

	page		page
DISMANTLING AT THE BENCH		COMPLETION AT THE BENCH	
- Sequence of operations	1	- Refitting various components	68
- 2000 i.e. engine - cross section	15	- Adjusting tension of counter shaft double-sided toothed belt	70
- 2000 i.e. engine - longitudinal section	16	- Completion of assembly	71
CYLINDER BORES - CYLINDER BLOCK		FUEL SYSTEM	
- Cylinder bores	17	- Diagram of fuel system	83
- Cylinder block	18	- Removing/refitting inlet manifold	85
CRANKCASE COMPONENTS		COOLING SYSTEM	
- Crankshaft	19	- Water pump	87
- Main bearings	21	- Thermostat	88
- Measuring main journal running clearances	22	- Diagram of cooling system	90
- Thrust washers - Fitting main bearing caps	23	LUBRICATION	
- Crankshaft rear cover	25	- Diagram of lubrication system	92
- Crankshaft front cover		- Crankshaft-driven oil pump	94
with incorporated oil pump	26	SPECIAL TOOLS	
- Vibration damping system with counter shafts	27	TORQUE WRENCH SETTINGS	
- Flywheel	32		97
- Piston/connecting rod assembly - Pistons	33		
- Gudgeon pins - Piston rings	35		
- Connecting rods	37		
- Small end bushes - Fitting piston/ connecting rod assembly	38		
- Big end bearings	40		
- Measuring crankpin running clearances	41		
- Positioning TDC and rpm sensor mounting plate	42		
CYLINDER HEAD			
- Dismantling cylinder head	43		
- Valves	47		
- Valve guides	48		
- Valve springs	52		
- Upper cylinder head - Camshaft	53		
- Tappets	54		
- Fitting cylinder head	55		
- Adjusting valve clearances	56		
ASSEMBLY AT THE BENCH			
- Tightening cylinder head	59		
- Refitting various components	60		
- 2000 i.e. turbo engine - cross section	61		
- 2000 i.e. turbo engine - longitudinal section	62		
TIMING GEAR			
- Refitting timing gear components	64		
- Adjusting valve timing	66		
- Adjusting timing belt tension	67		

Sequence of operations

- Drain the engine oil using spanner 1850113000 while the engine is raised off the ground by the hoist;
- secure the engine on the rotating stand using brackets 1861001011;
- then remove the parts illustrated in the photos below.

NOTE *The 2000 i.e. turbo engine is fitted to the DELTA, and the 2000 i.e. engine is fitted to the PRISMA. Unless otherwise specified, the dismantling, overhaul and reassembly procedures and the technical data contained in the following pages apply to both engine types.*



The crankcase breather bolt must be slackened to remove the exhaust manifold.

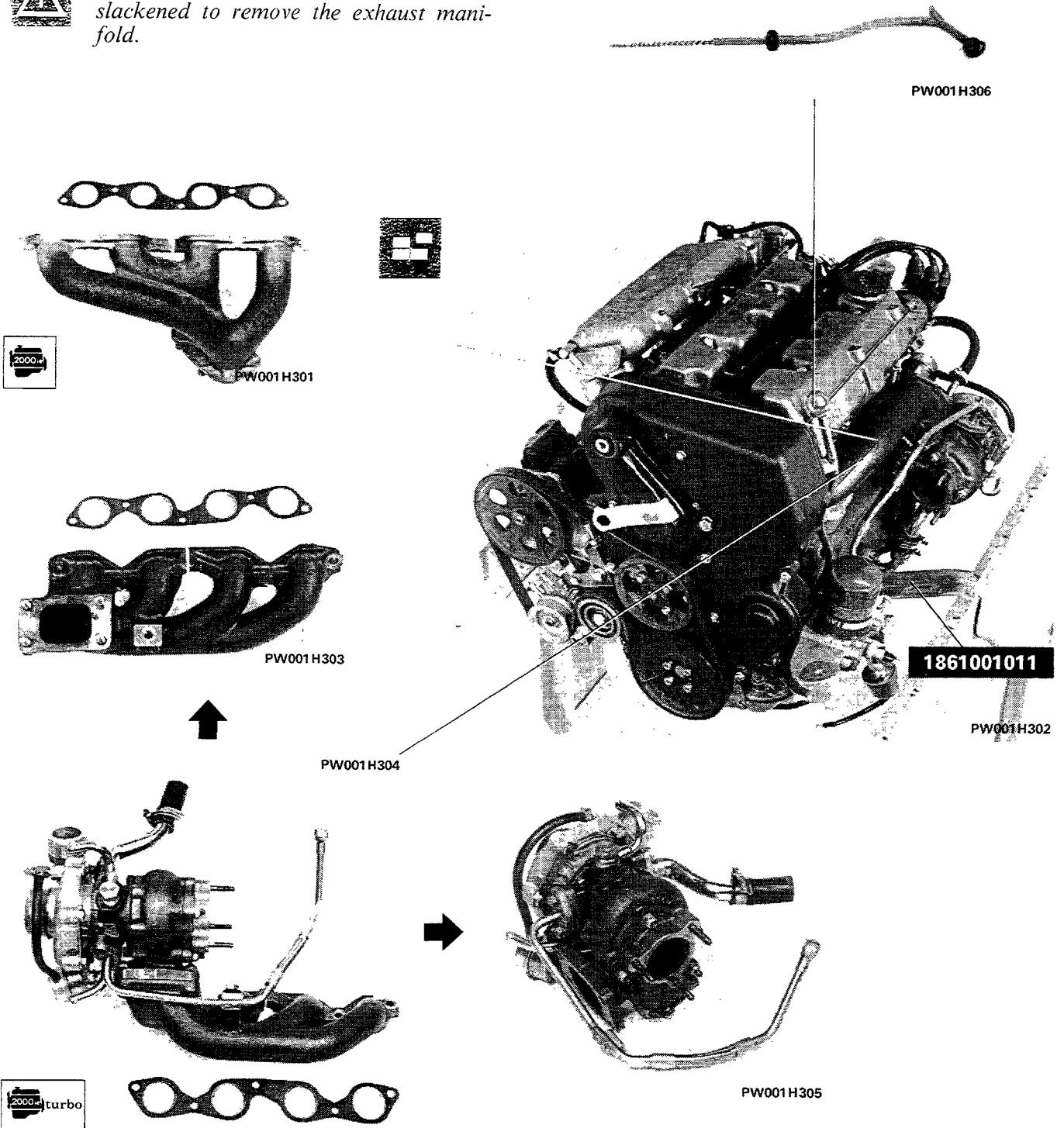

Engine

Dismantling at the bench

2000 ie 2000 ie turbo

10.

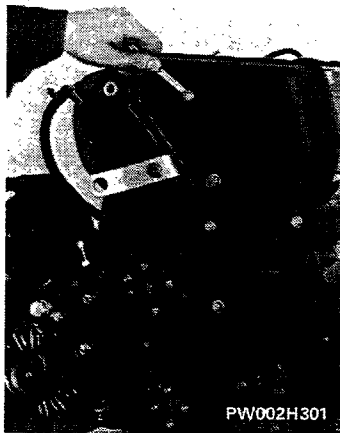

PW002H301



PW002H302



PW002H303



PW002H305



1861001011

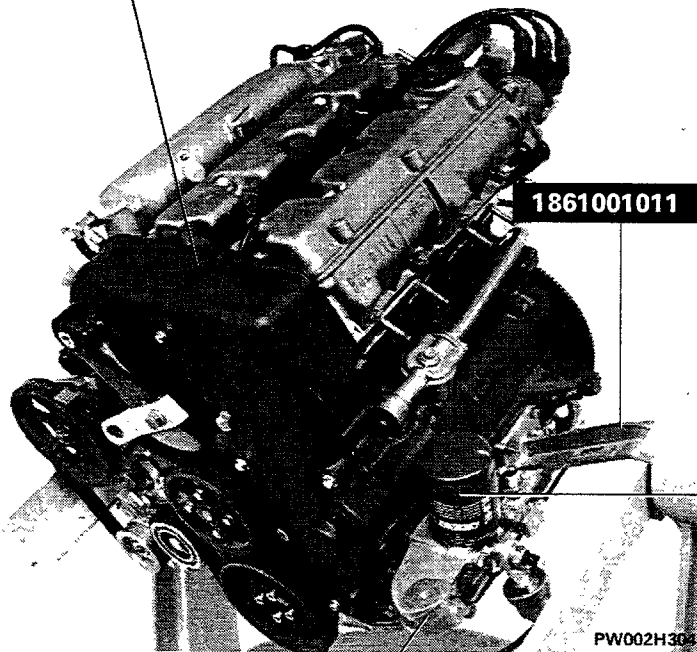

PW002H308



PW002H306

1860757000*
1860758000**

- * 2000 ie engine
- ** 2000 ie turbo engine

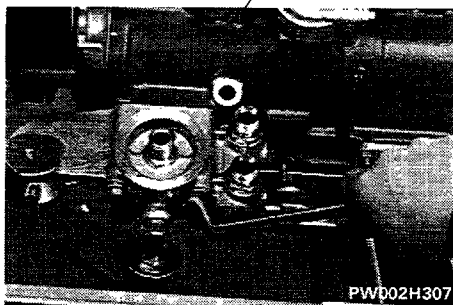

PW002H307

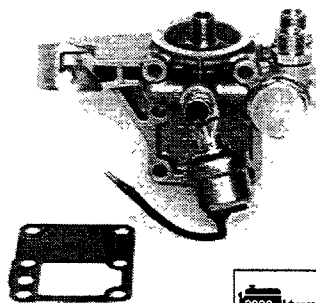

PW002H308

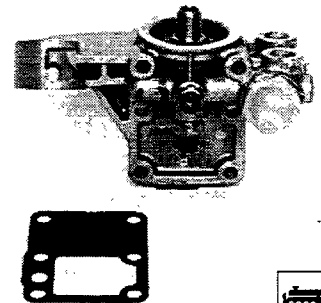

PW002H309



- remove the belt after releasing the tension by slackening the adjustment bolt, then remove the belt tensioner by unscrewing the two bolts indicated.

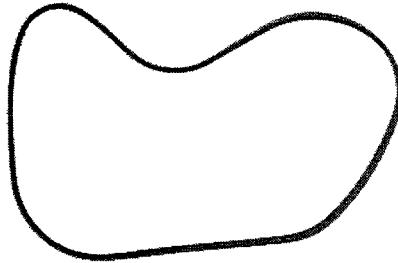
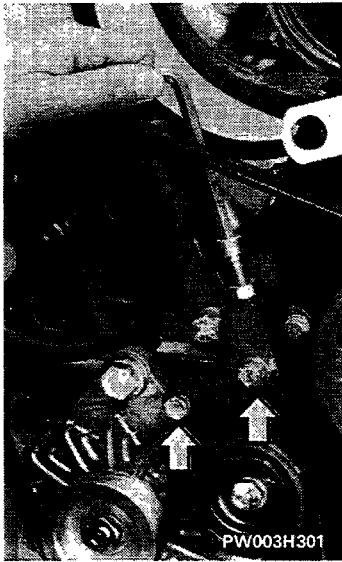

PW003H302



PW003H303

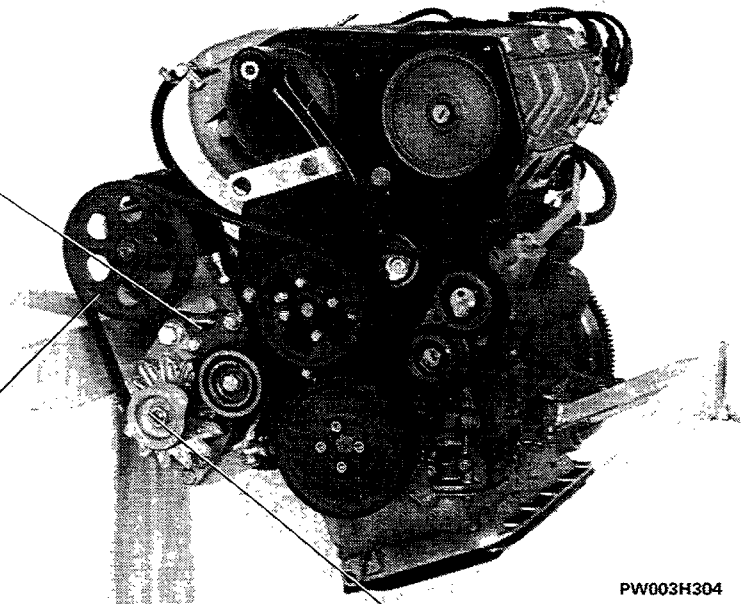

PW003H304

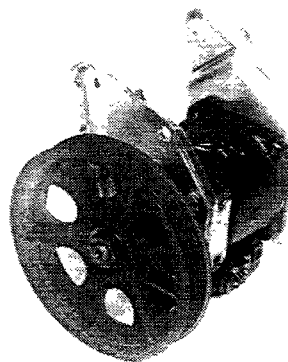
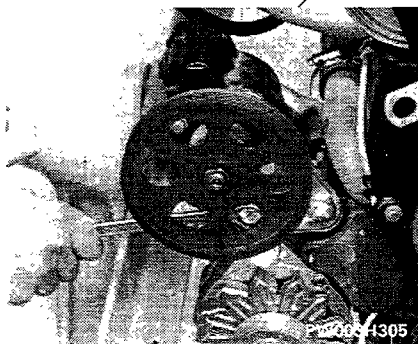

PW003H306

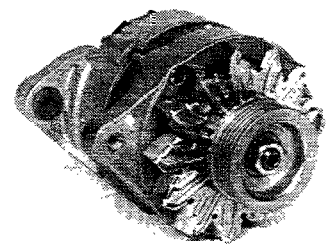

PW003H307

10.



PW004H302



To facilitate removal of the inlet manifold, at least the two central studs should be removed.

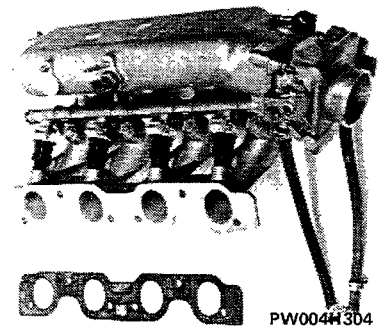

PW004H304

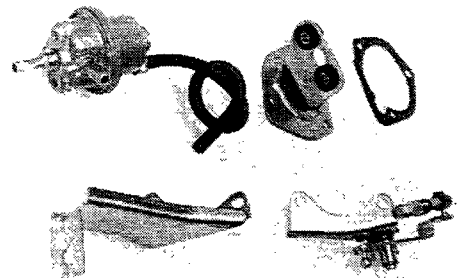

PW004H305

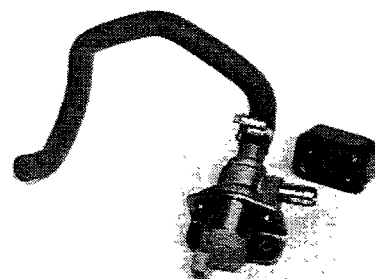

PW004H307

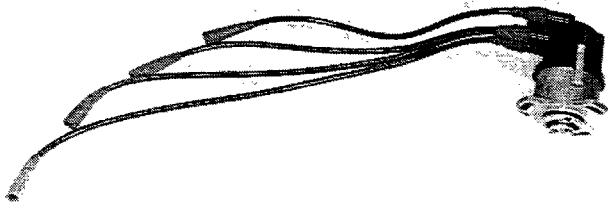

PW004H301

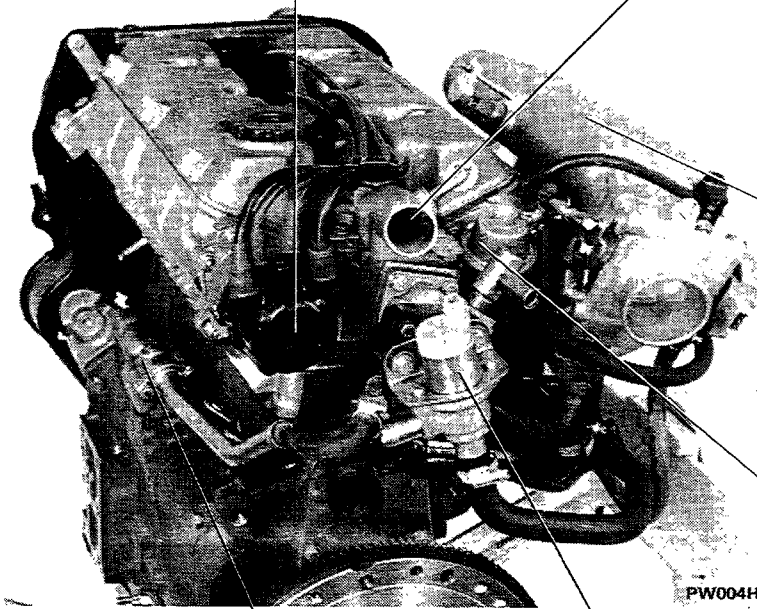

PW004H303

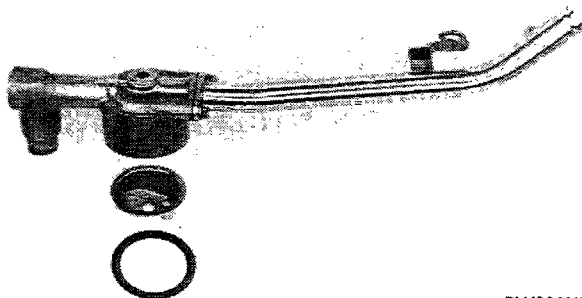

PW004H306

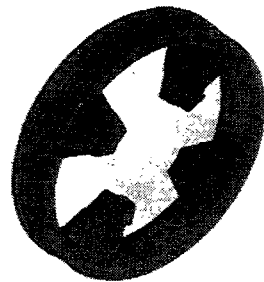
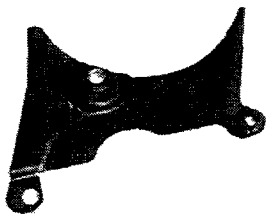
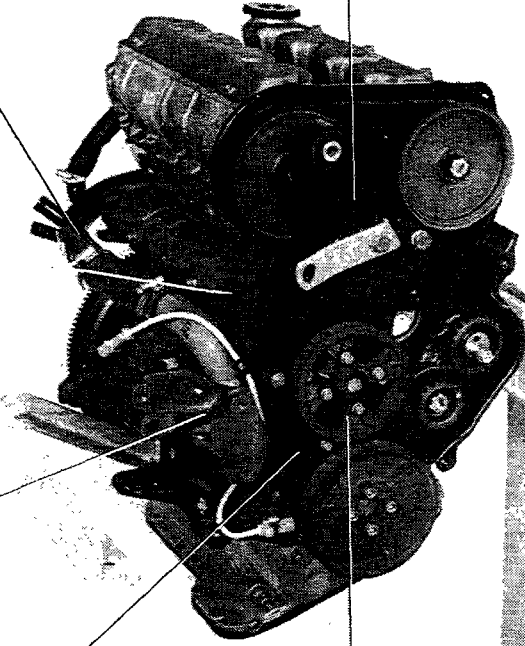
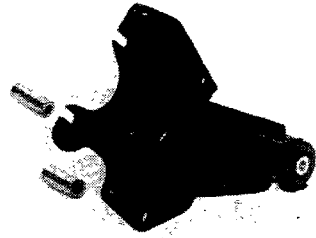
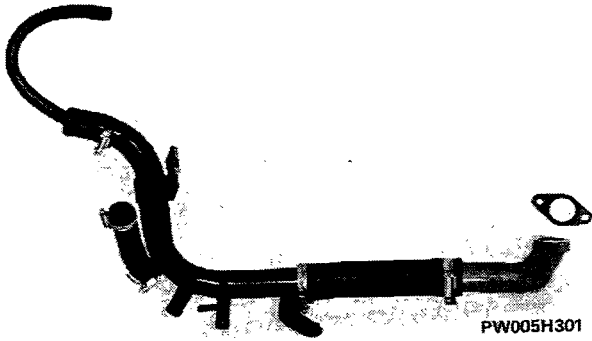

Engine

Dismantling at the bench

2000 ie | 2000 ie turbo

10.

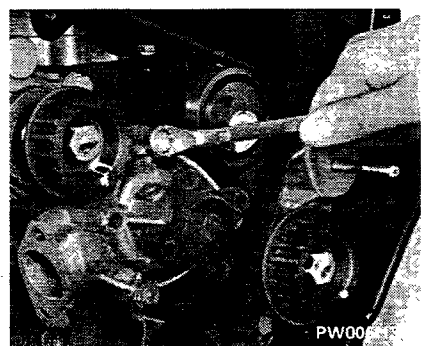

PW006H301

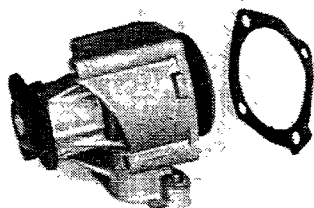

PW006H302

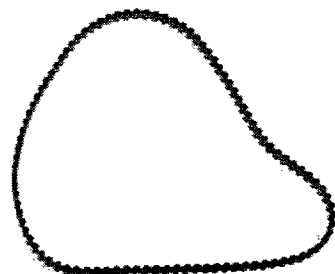

PW006H303

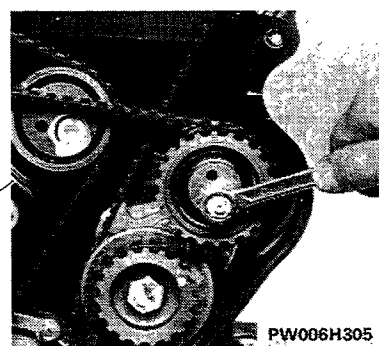

PW006H305

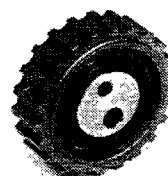

PW006H306

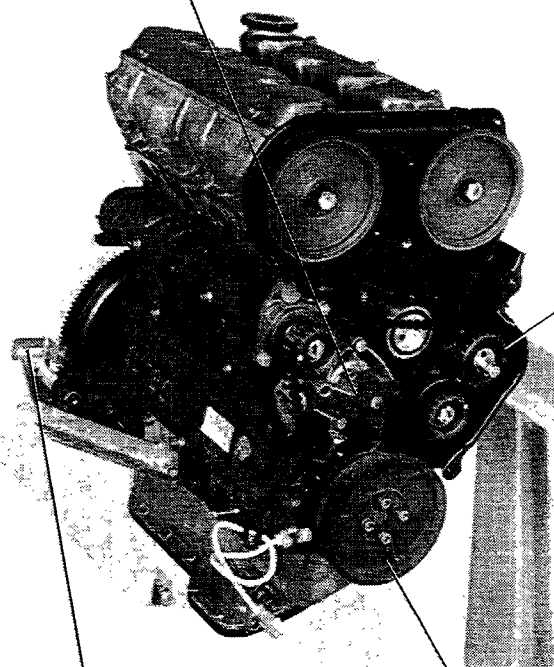

PW006H304

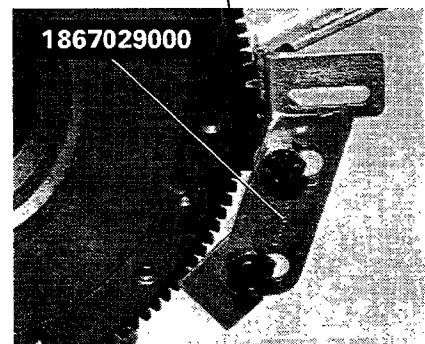

1867029000

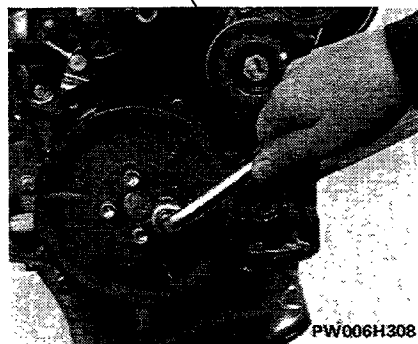

PW006H308

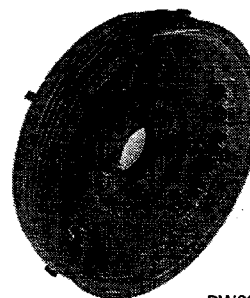

PW006H309

- mount the flywheel locking tool 1867029000

- use the flywheel locking tool 1867029000 when dismantling the water pump pulley

- as a stop for tool 1860473000, use a bolt, shown by the arrow, screwed into the cylinder head

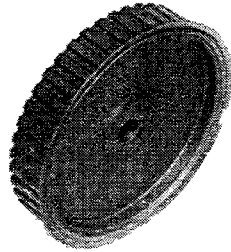
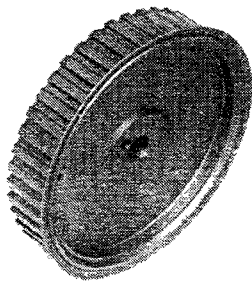

PW007H301

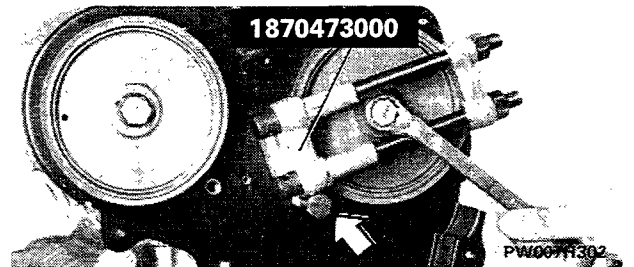

Left-hand threaded bolt

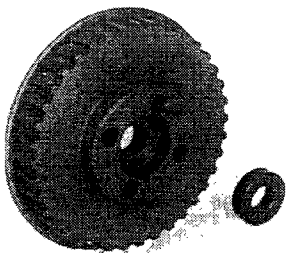
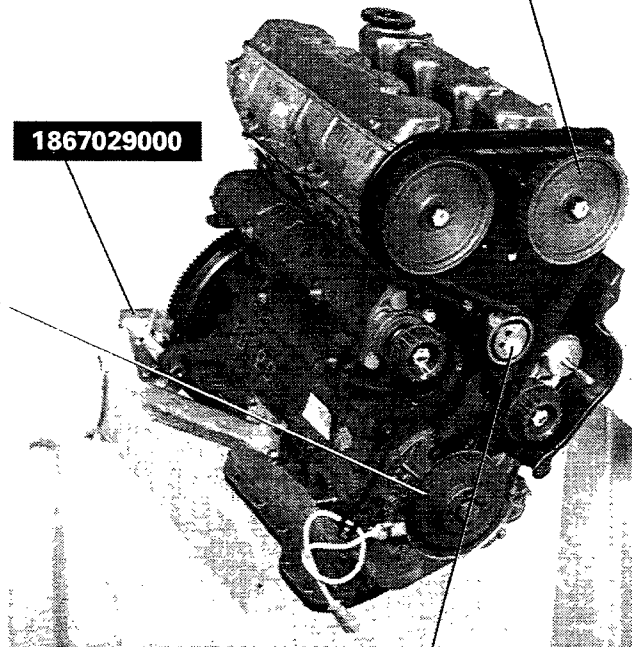
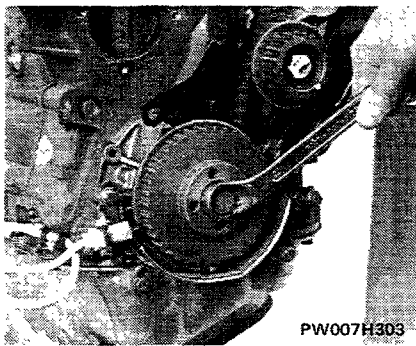

- use the flywheel locking tool 1867029000 to dismantle the sprocket



PW007H306

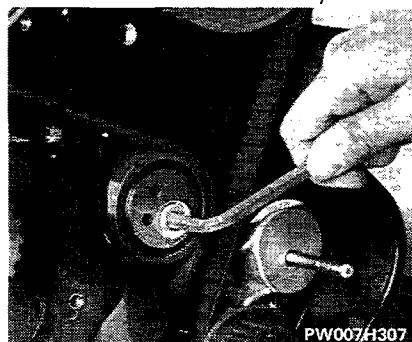

PW007H308

Engine

Dismantling at the bench

2000ie 2000ie turbo

10.

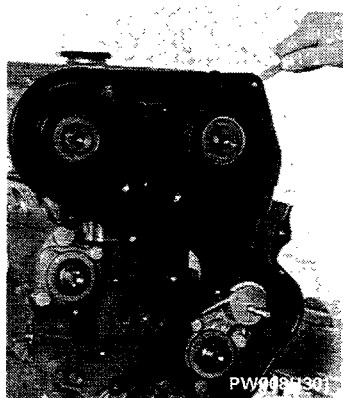

- as a stop for tool 1860473000, use a bolt, shown by the arrow, screwed into the block

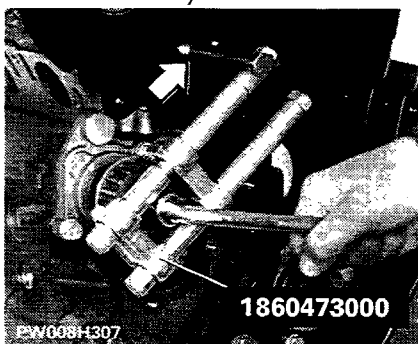
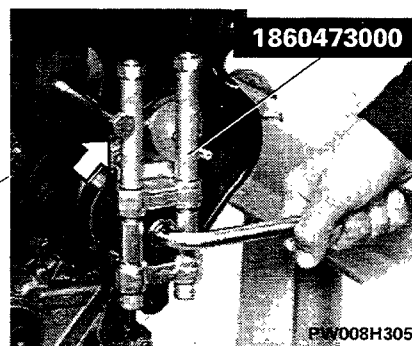
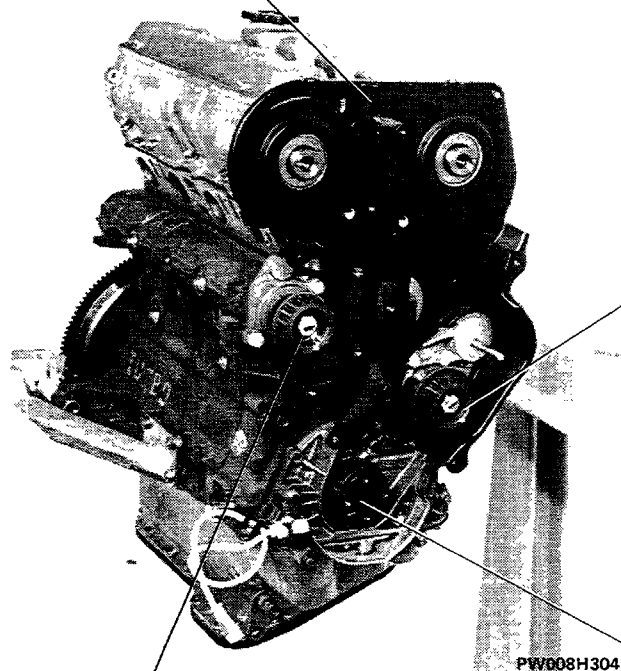

- as a stop for tool 1860473000, use a bolt, shown by the arrows, screwed into the block

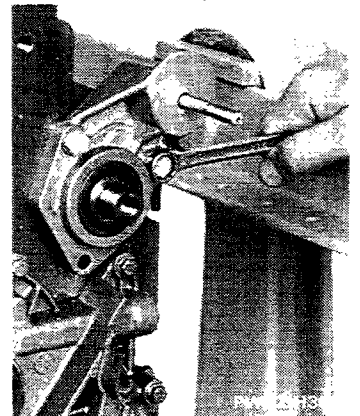
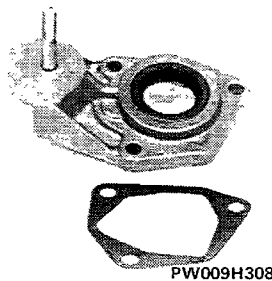
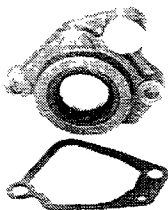
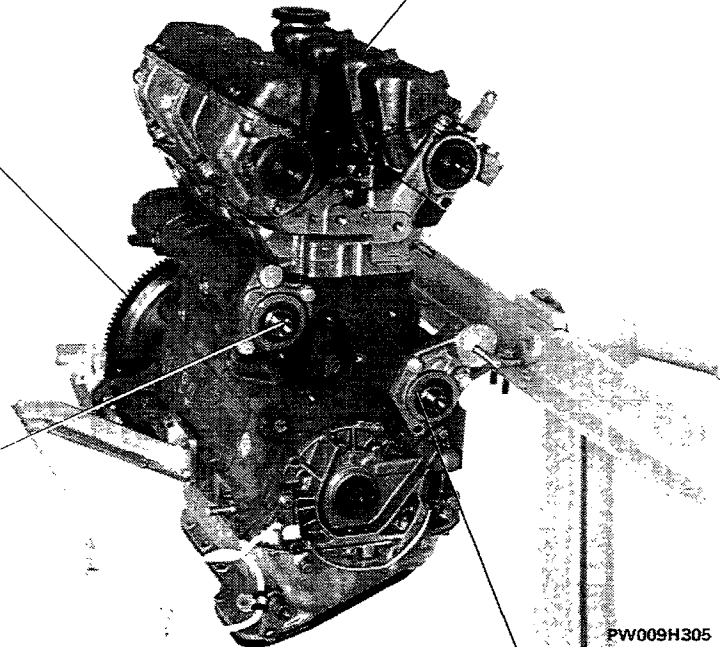
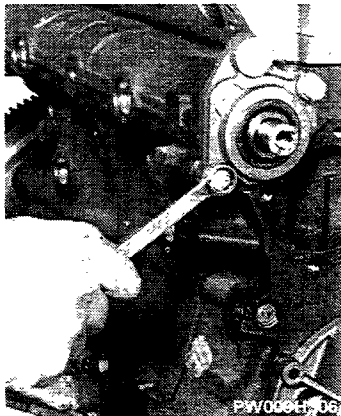
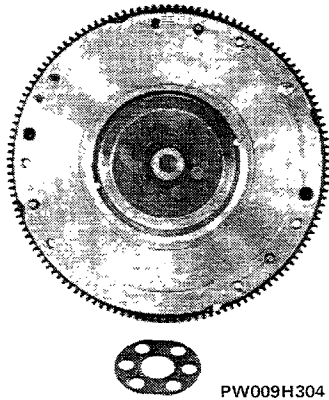
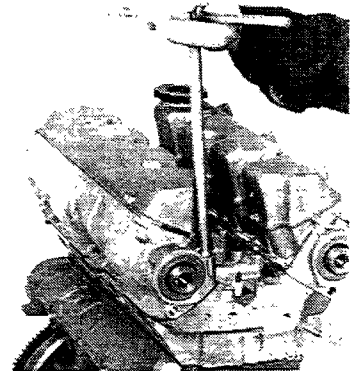
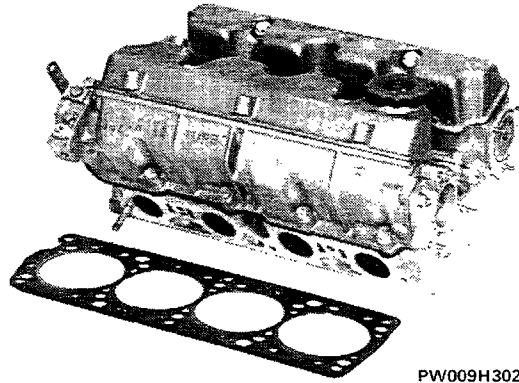
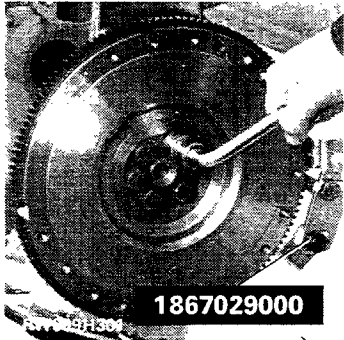

10.

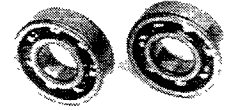
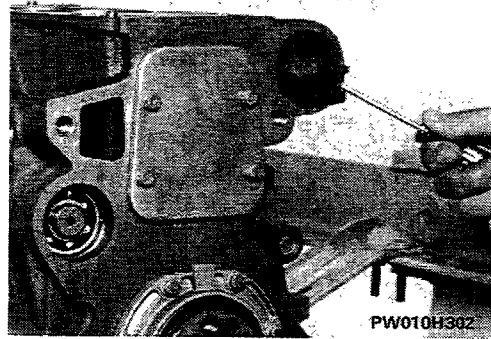
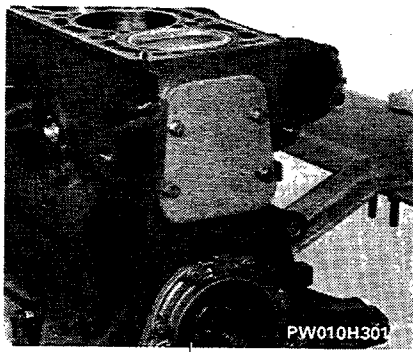

PW010H303

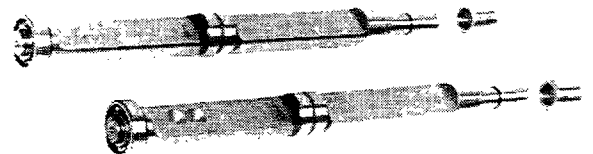
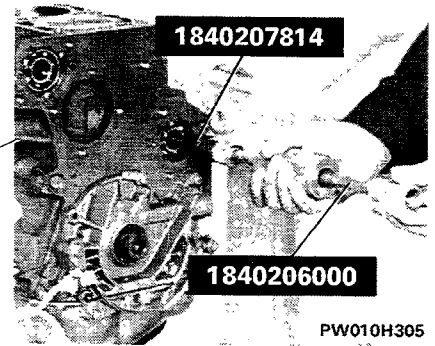
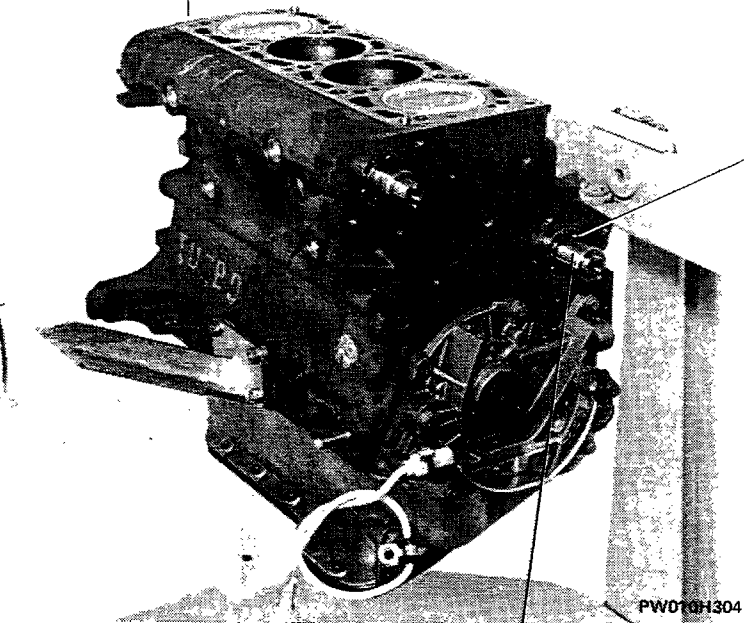

PW010H306

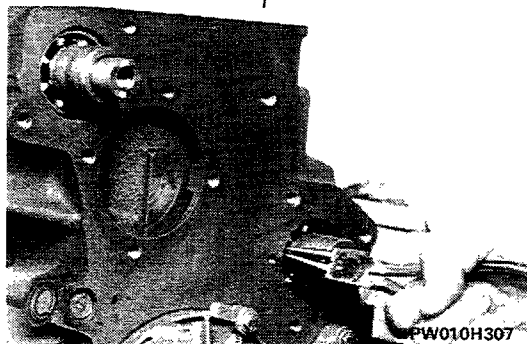

- do the same for the left counter-rotating shaft



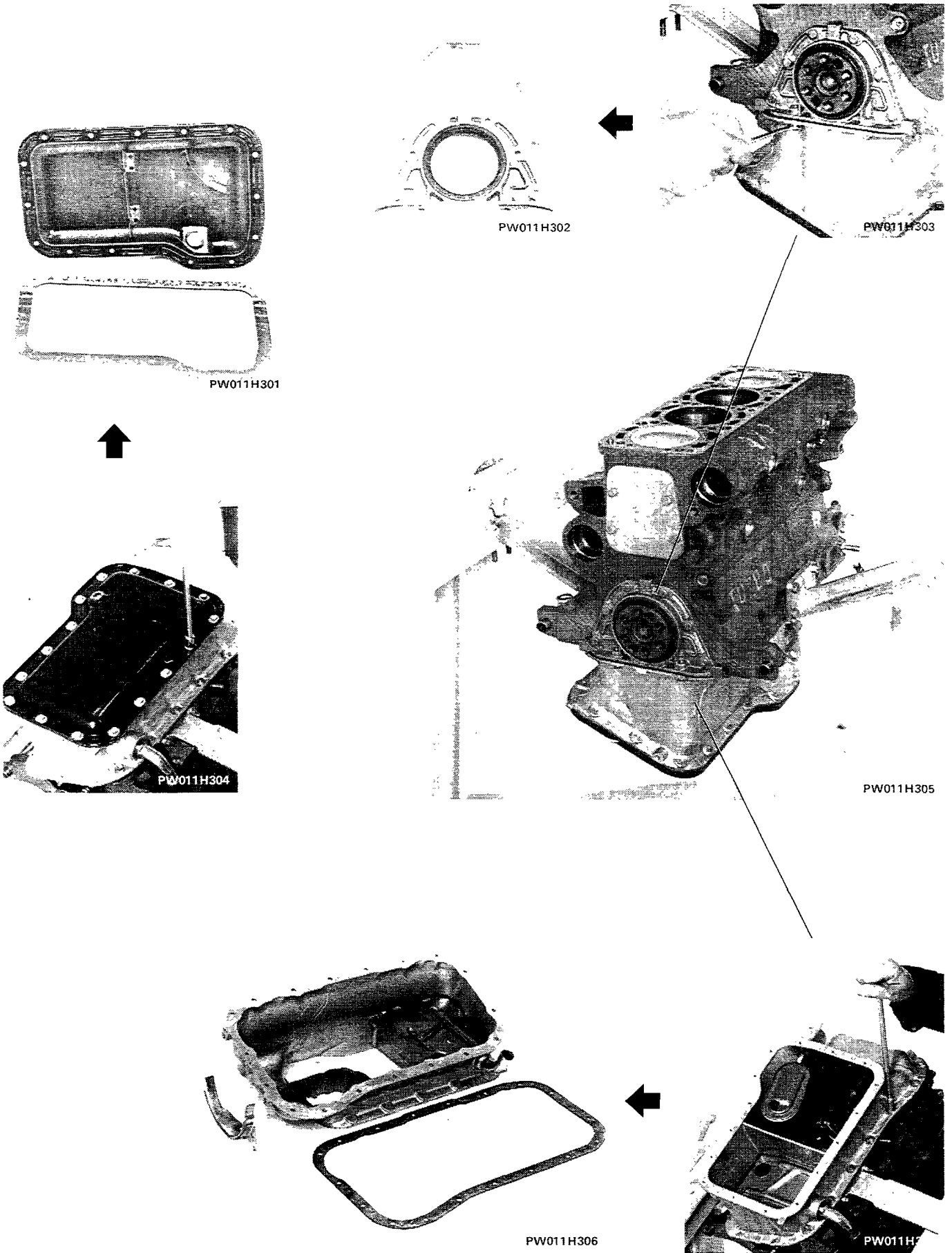

10.

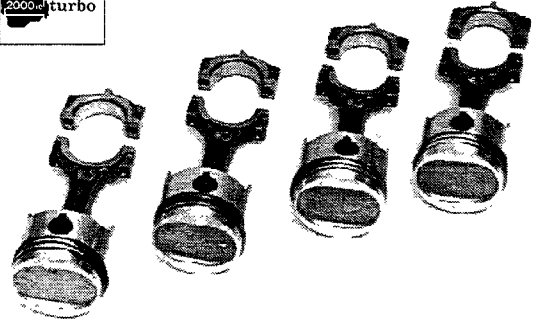
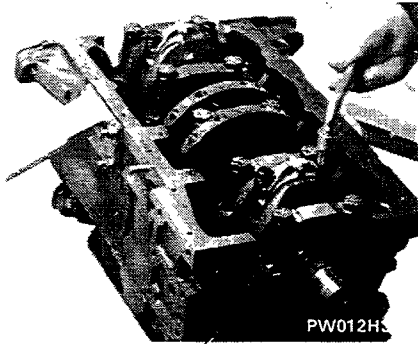

PW012H302

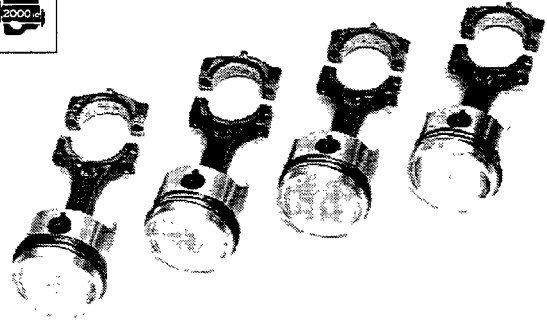

PW012H303

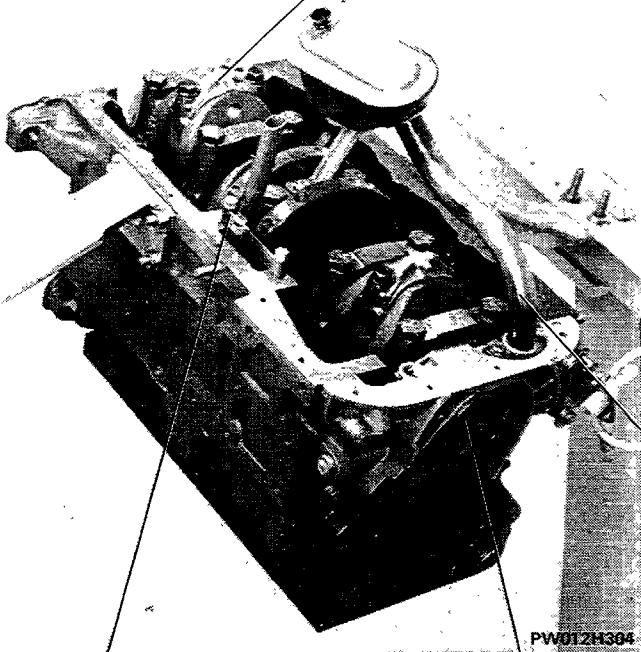

PW012H304

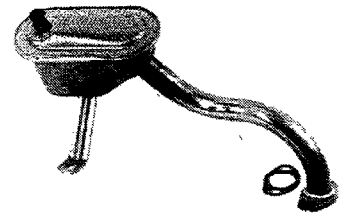

PW012H305

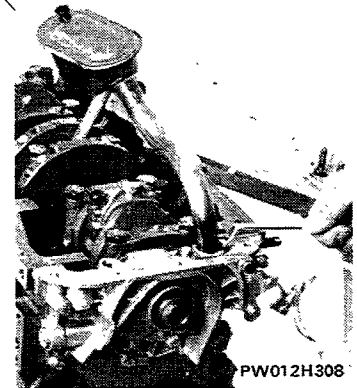

PW012H308



PW012H306

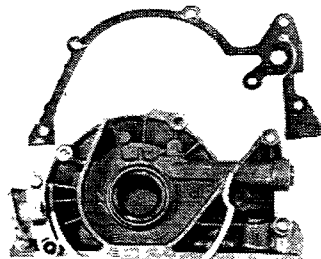

PW012H307

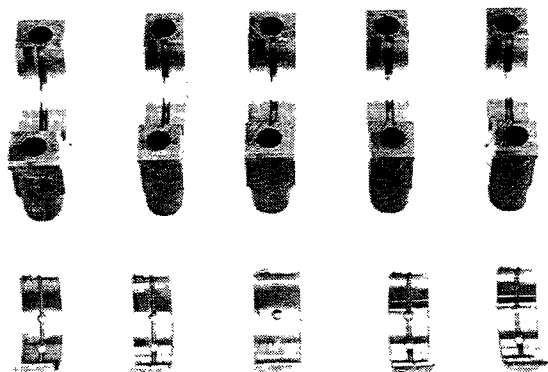

PW013H301

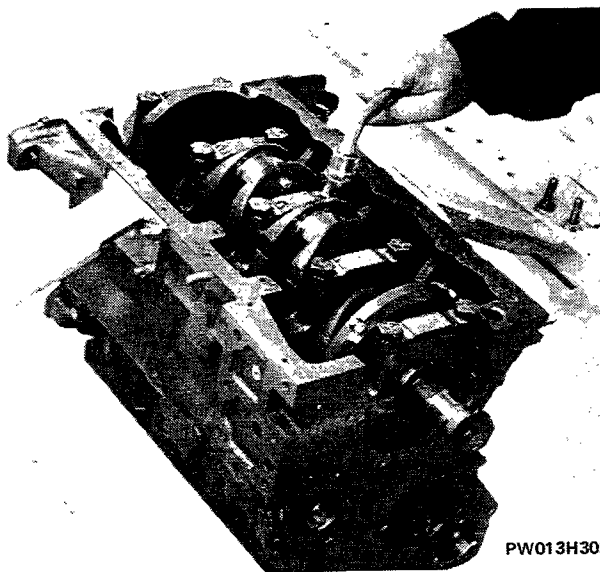

PW013H302



The numbers stamped on the cylinder block and main bearing caps must be the same, and legible from the flywheel side. The bearing cap positions are indicated by a series of notches starting from the timing gear side.

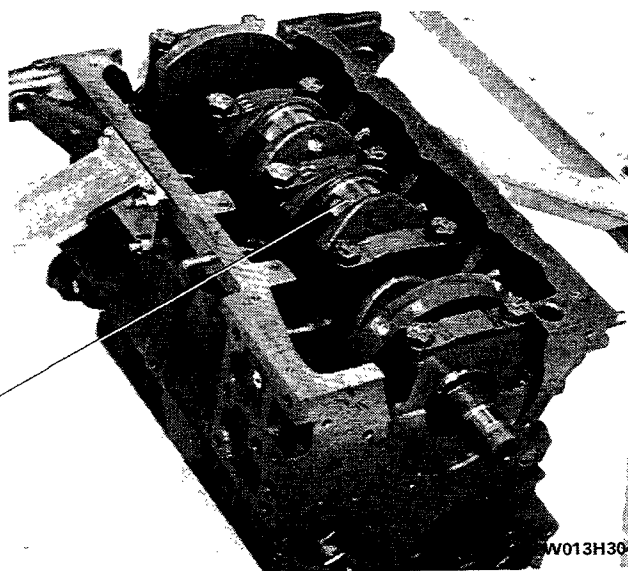

PW013H304

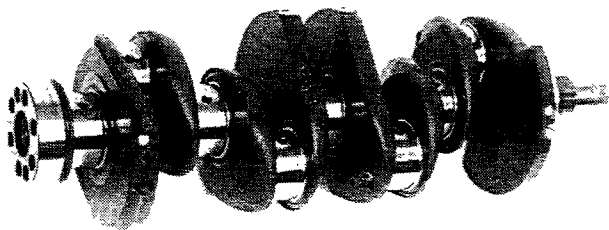

PW013H303



NOTE After dismantling the engine, thoroughly clean the dismantled parts and check their condition. The following pages contain instructions for the main checking and measuring operations necessary in order to determine whether the components are suitable for reuse. The correct refitting sequences are also described, and special tools are indicated to facilitate the engine reassembly procedure.

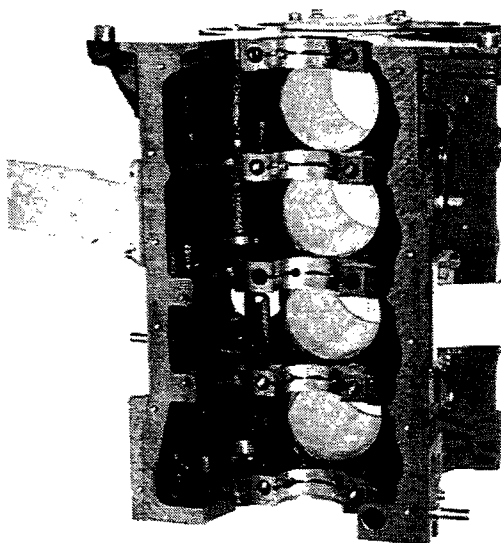

PW013H305

10.

Set of gaskets for engine overhaul

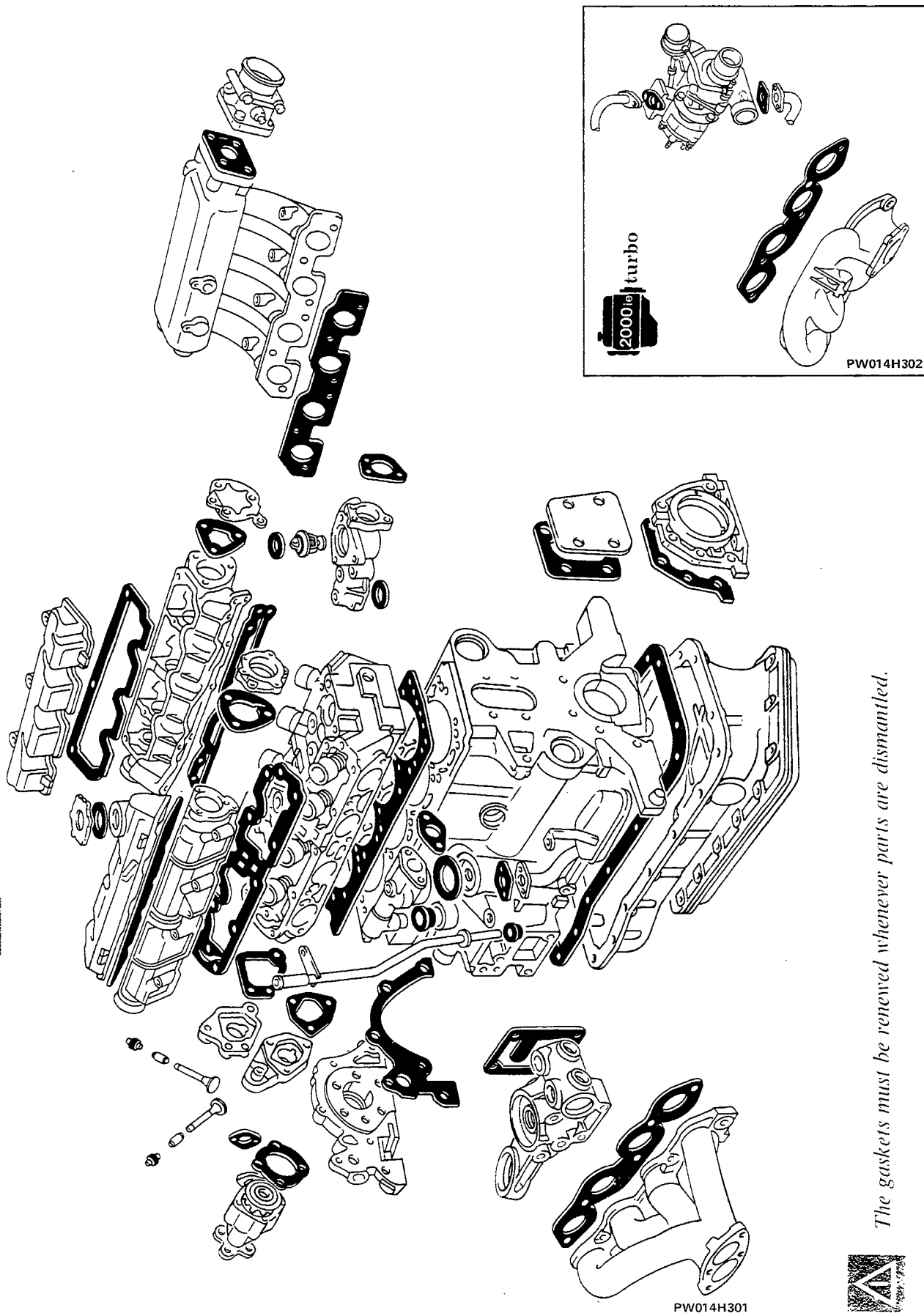

The gaskets must be renewed whenever parts are dismantled.



PW014H301

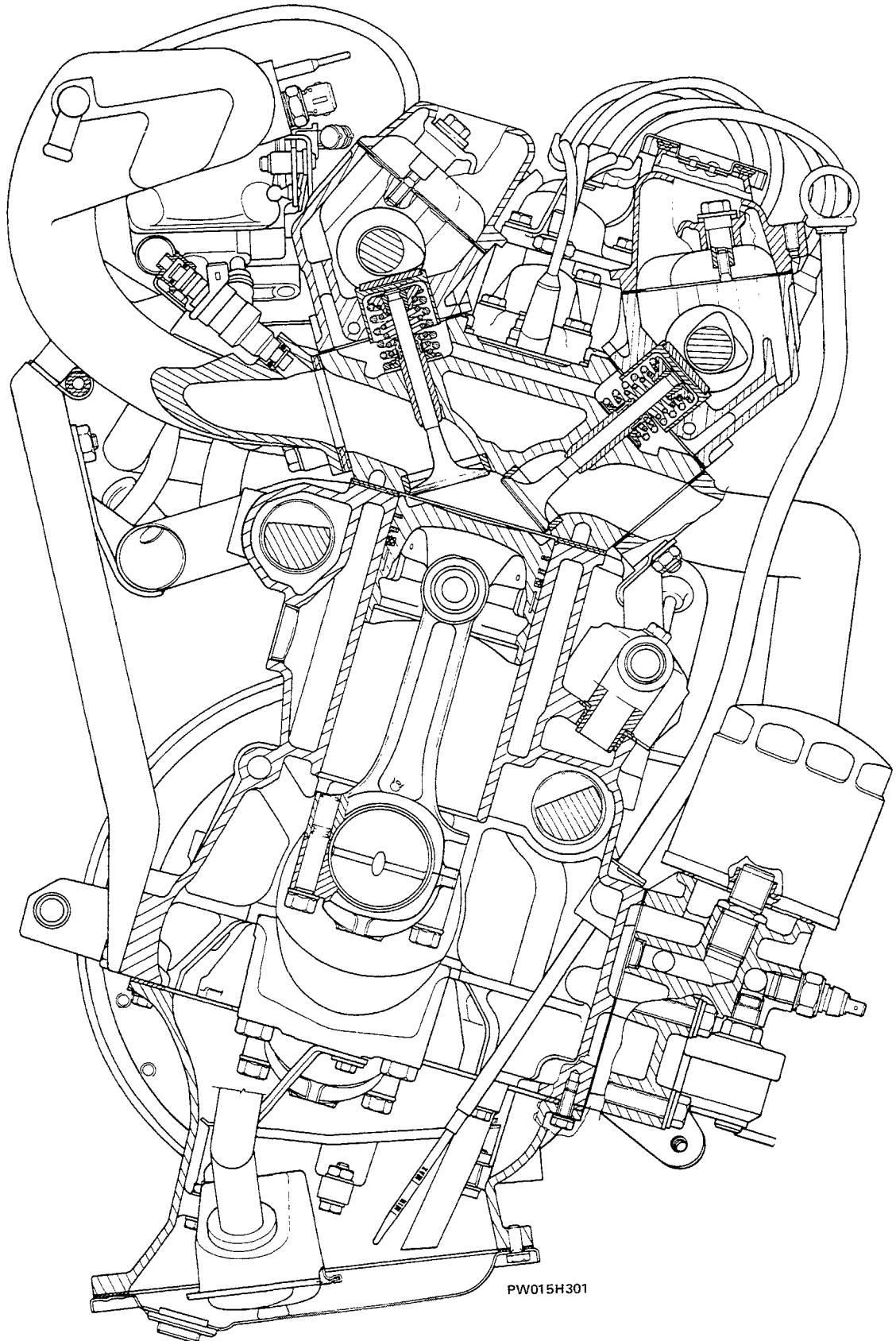

PW015H301

10.

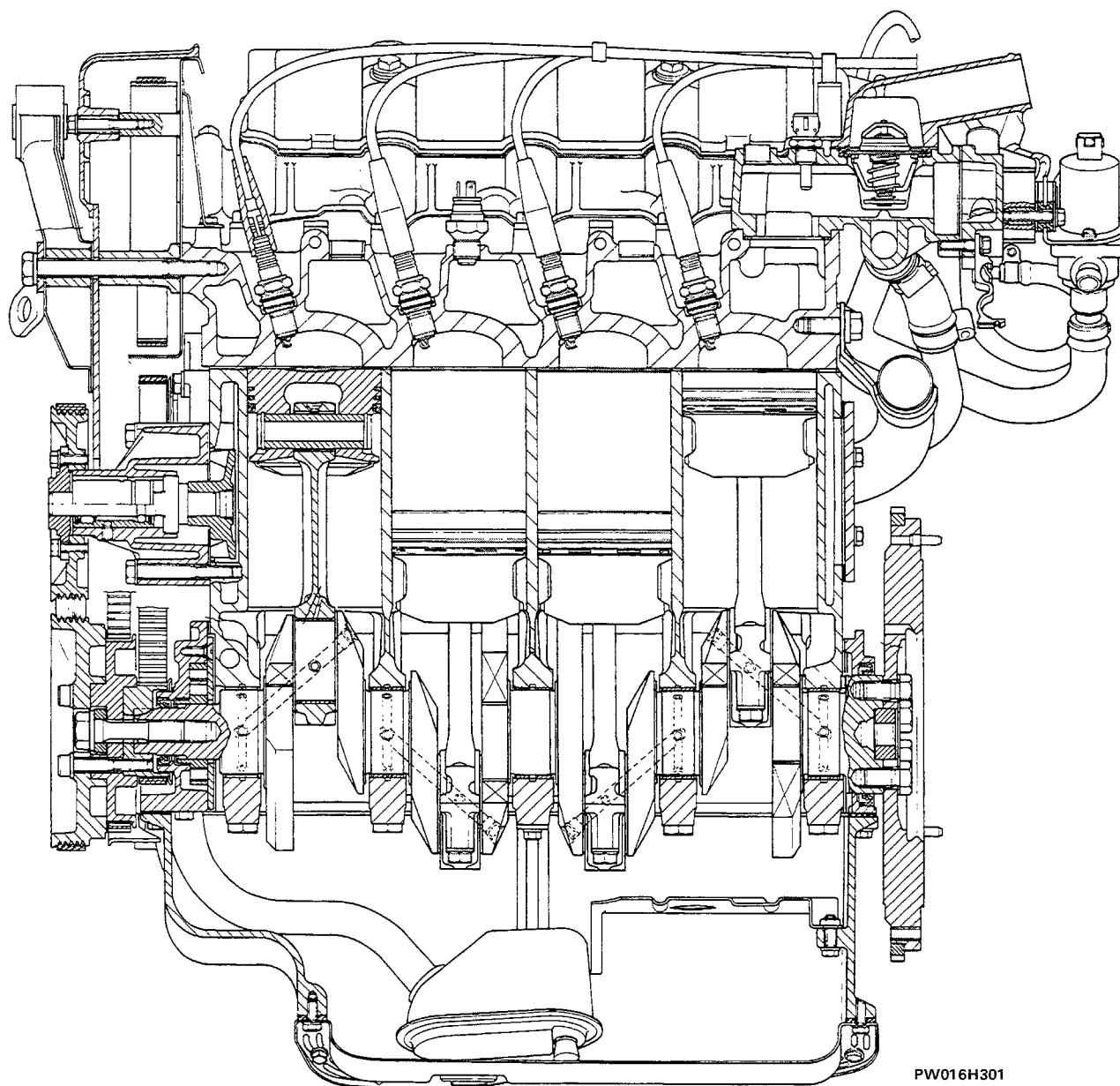

LONGITUDINAL SECTION 

CYLINDER BORES

Checking and measuring

Measure the maximum out-of-round, taper and wear of the cylinder bores.
Visually inspect all sliding surfaces.

NOTE *If rebored, all the cylinders must be machined to the same oversize.
The permitted tolerances for a cylinder rebore are:
taper (difference between 1st and 3rd measurement) ± 0.005 mm;
out-of-round (difference between a and b) ± 0.005 mm.*

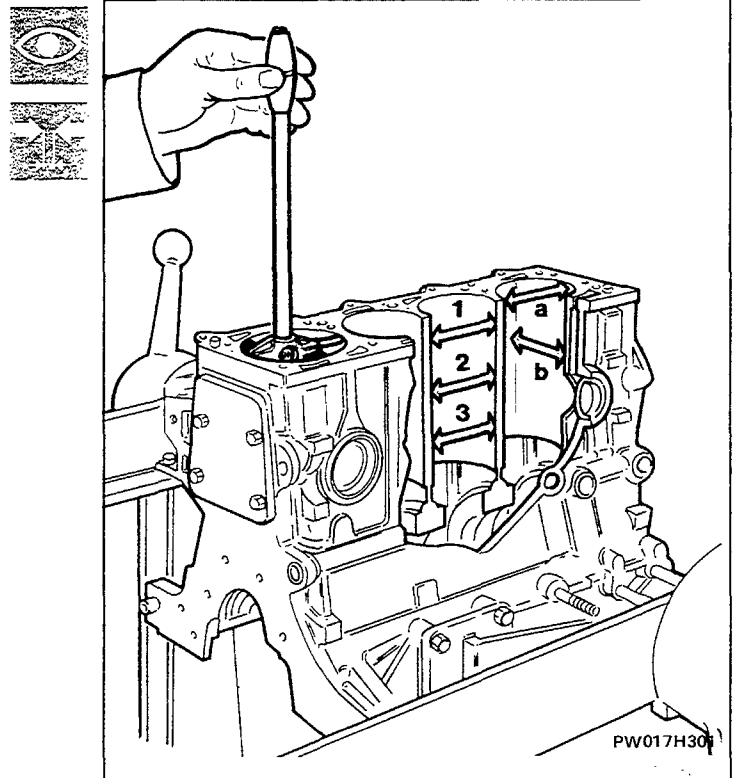

Location of piston cooling jets

The cylinder block has four jets (two of which are arrowed) fed directly from the main bearings.
These jets serve to cool and lubricate the pistons and gudgeon pins.

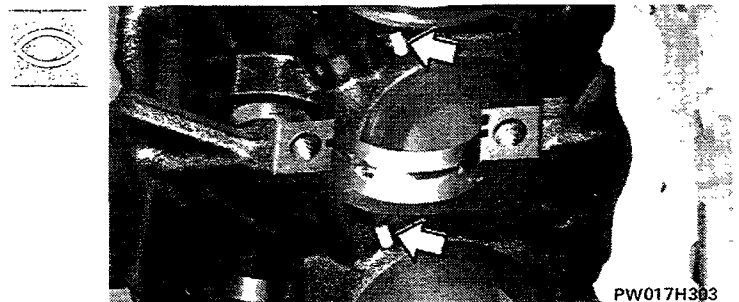

Grades of standard diameter cylinder bores

The arrows show the letters identifying the cylinder bore grades.

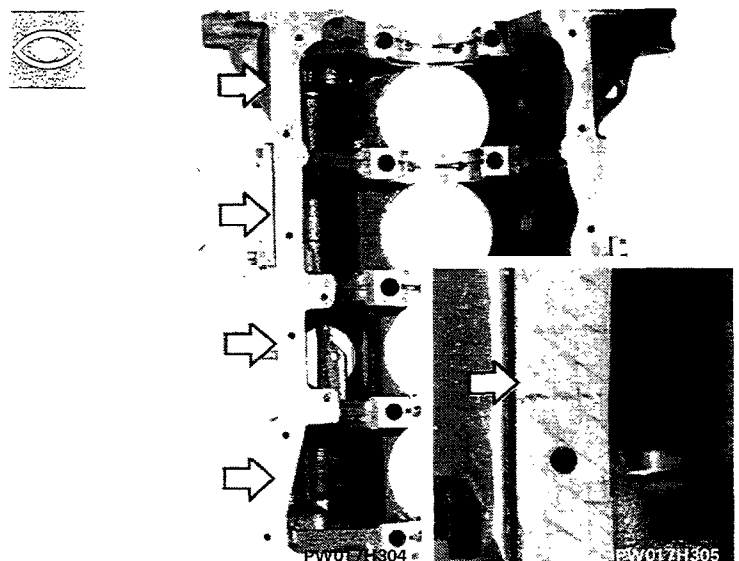

10.

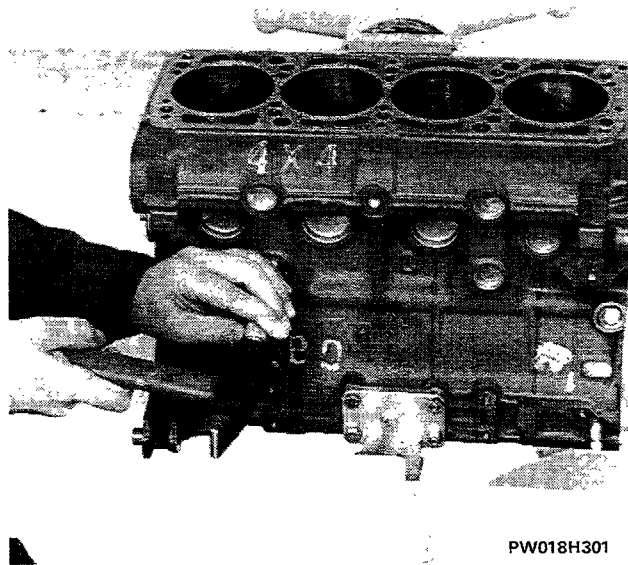

CYLINDER BLOCK

Removing/refitting core plugs in block (inlet manifold side)



Before fitting the plugs, smear sealing compound over the surfaces in contact with the block.

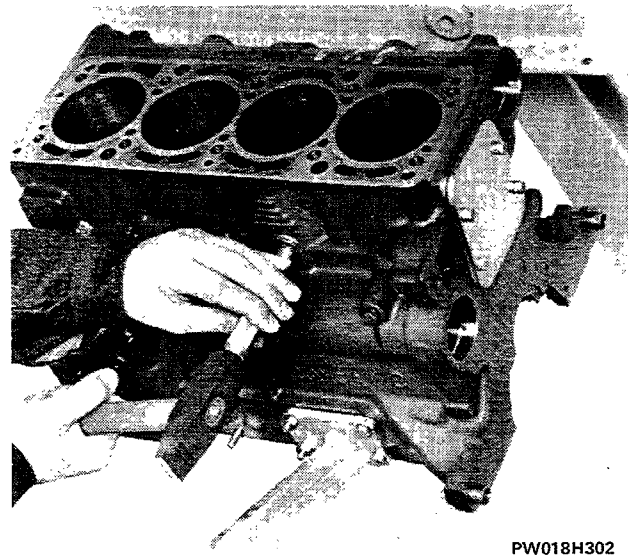

Removing/refitting plate (flywheel side) and core plug in block (exhaust manifold side)



Before fitting the plug and plate, smear sealing compound over the surfaces in contact with the block.

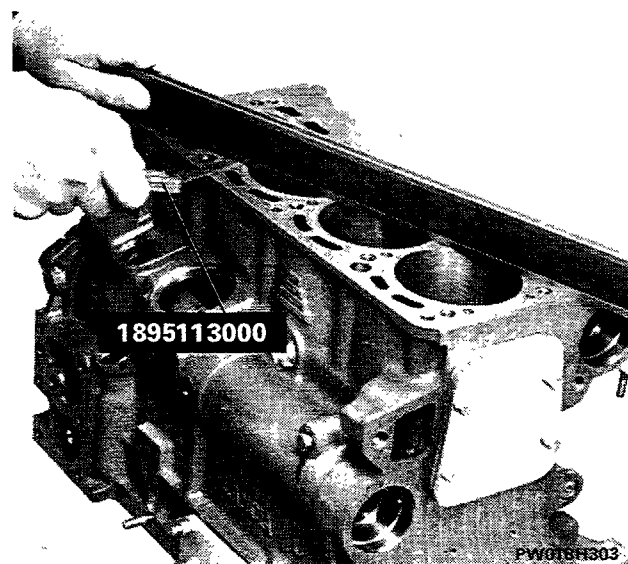

Checking cylinder block top face using a rule and feeler gauge

NOTE *The maximum distortion of the cylinder block top face must not exceed 0.1 mm.*

CRANKSHAFT

NOTE *In order to improve its endurance and wear-resistance properties, the crankshaft has been subjected to a nitriding treatment.*

When the crankshaft is reground, after the main bearing journals and crankpins have been machined to undersize, the crankshaft will have to be re-nitrided to prevent it breaking during operation. It will be necessary to refer this job to a specialist workshop, specifying that the treatment is liquid nitriding. After treatment, the crankshaft must not be straightened again, although it must be checked that the distortion is within the specified tolerance limits, otherwise the shaft will have to be replaced.

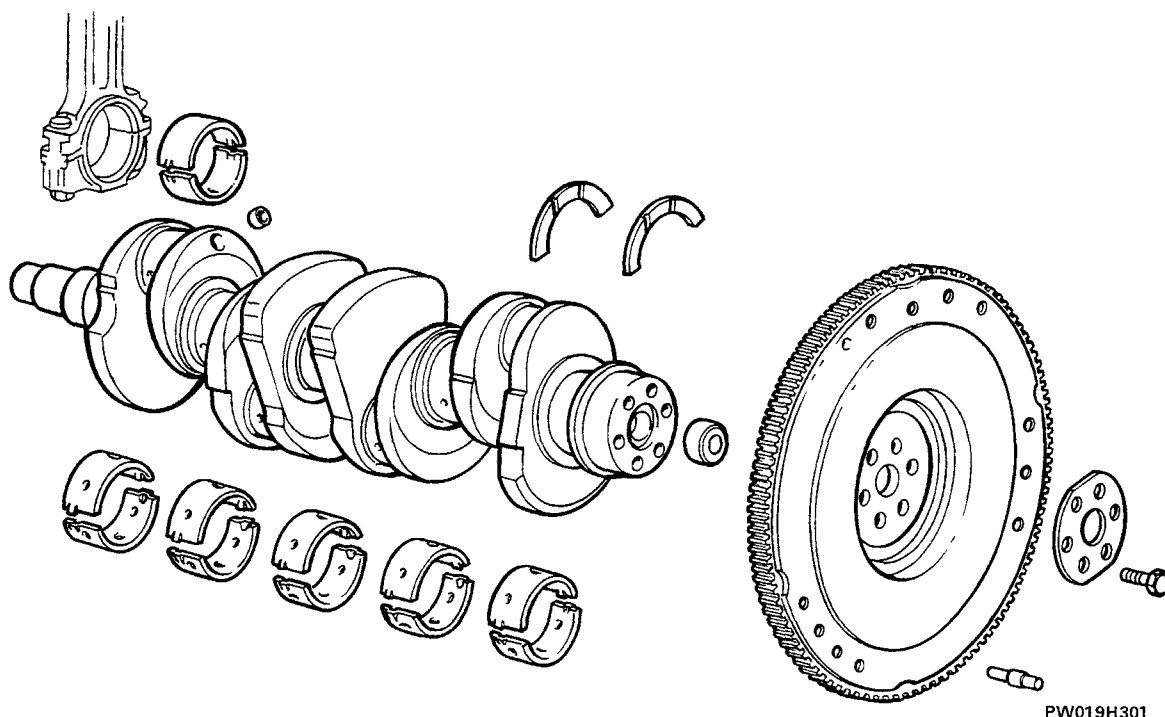

Measuring main journals and crankpins

The undersizes are 0.254 and 0.508 mm.

NOTE *The permitted tolerances for a crankshaft regrind are:*

<i>out-of round</i>	± 0.005 mm
<i>taper</i>	± 0.005 mm
<i>main journal misalignment</i>	± 0.025 mm
<i>crankpin misalignment</i>	± 0.125 mm



All the journals should always be reground to the same undersize so as not to alter the crankshaft balance.

NOTE *It is generally advisable to replace the crankshaft rather than to regrind it.*

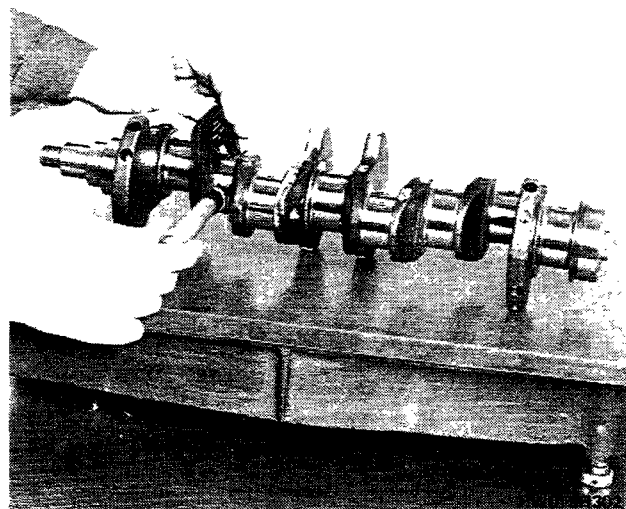

10.

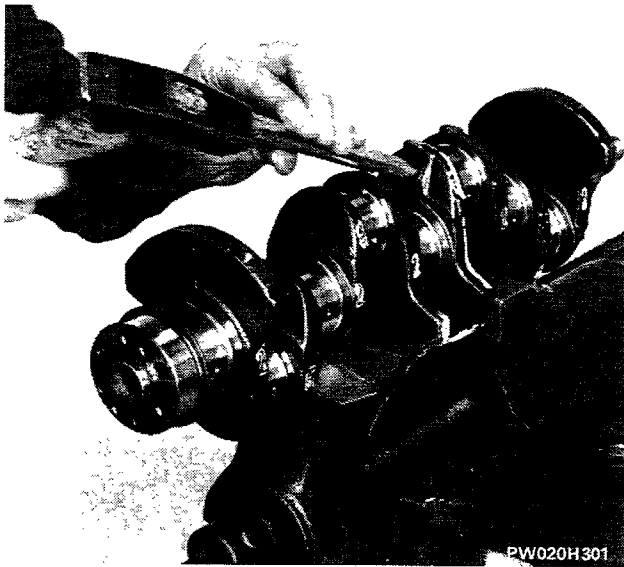

Removing/refitting oilway plugs

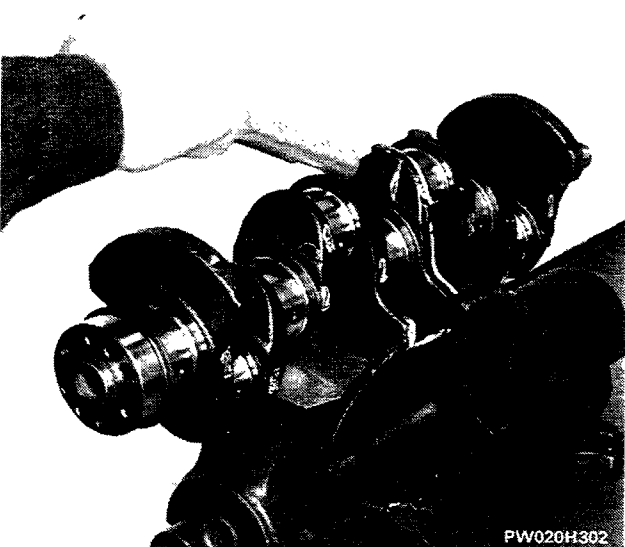

Reaming oilway plug seats



If the crankshaft is reground, it is essential to wash the lubrication channels thoroughly.

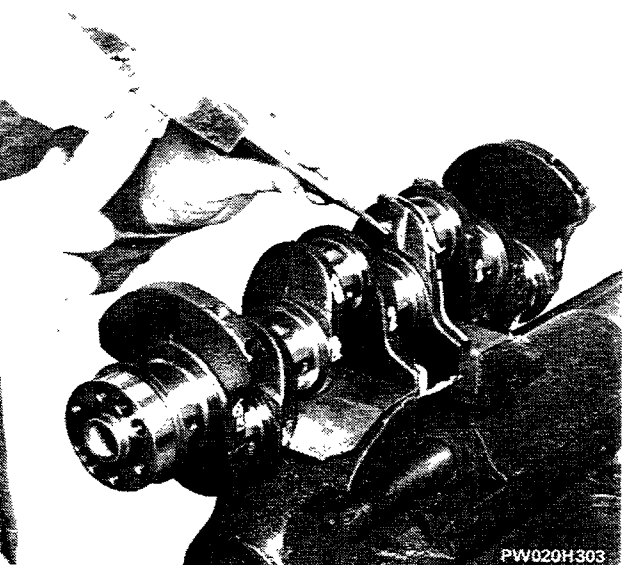

Staking oilway plugs

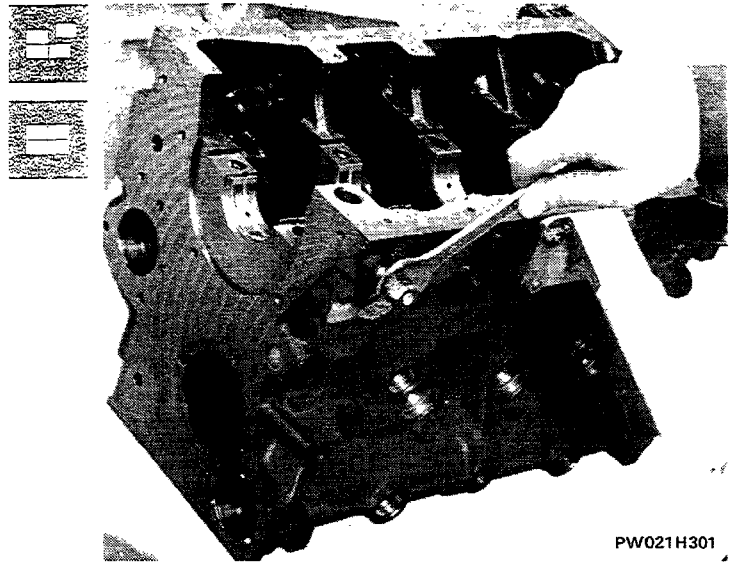

PW021H301

Removing/refitting stud

MAIN BEARINGS



Checking main bearings

NOTE Replacement main bearings are supplied in undersizes of 0.254 and 0.508 mm.



Do not attempt to make good the bearing shells.

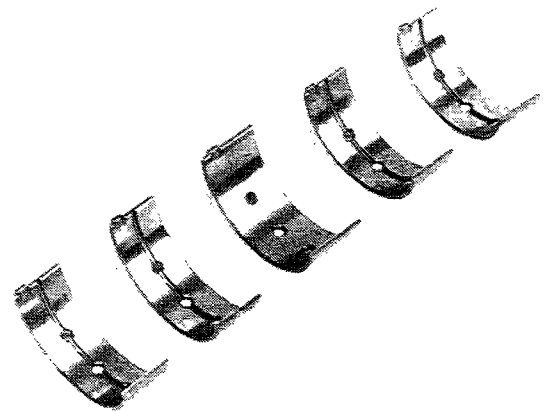

PW021H302

Fitting main bearings

NOTE Ensure that each bearing shell is fully supported in its location.



Thoroughly clean the bearing shell outer surfaces and their locations before assembly.

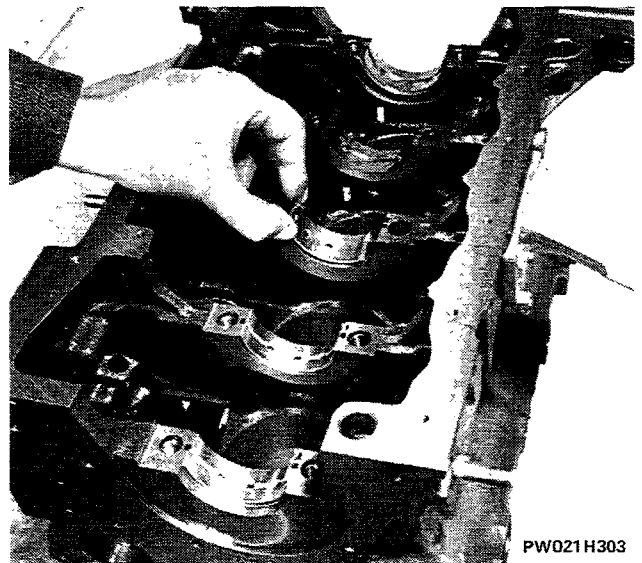

PW021H303

10.

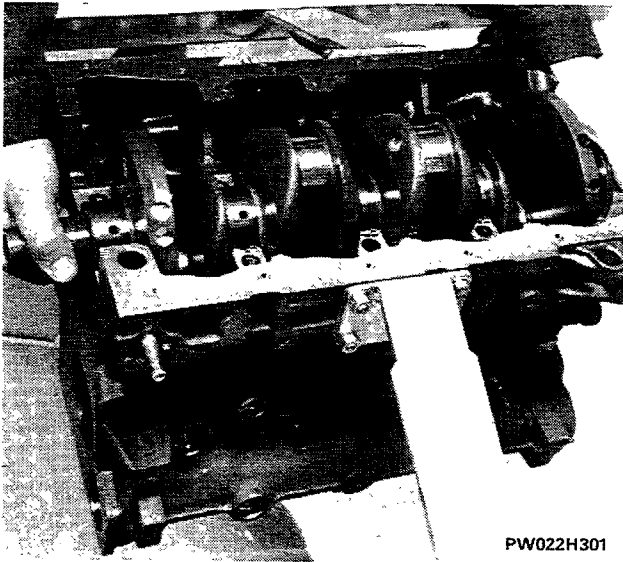

PW022H301



Fitting crankshaft

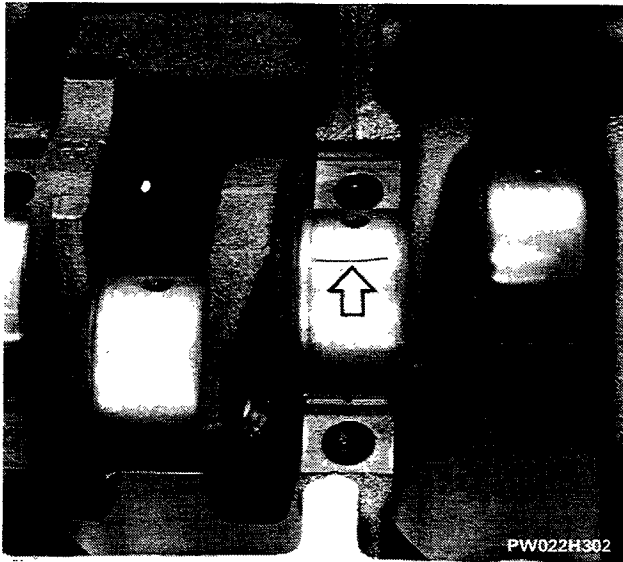

PW022H302



MEASURING MAIN JOURNAL RUNNING CLEARANCES

Using plastic calibrated filament to measure the running clearance (1st operation)

NOTE Check one journal at a time without moving the crankshaft during the checking operations.

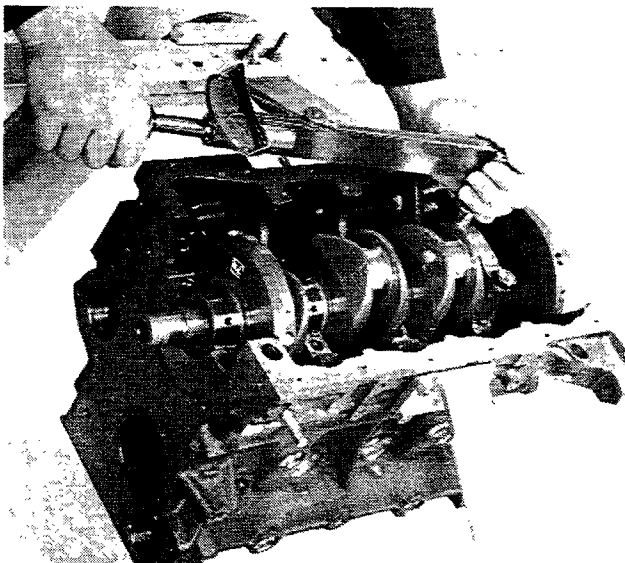

2 daNm



90°: side caps
130°: central cap



Tightening main bearing cap bolts to correct torque (2nd operation)

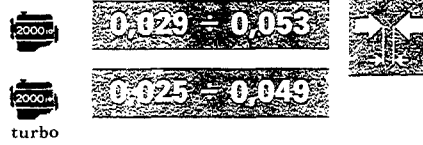

Measuring main journals with a special gauge (3rd operation)

THRUST WASHERS



Fitting thrust washers on flywheel side



Fit the thrust washers with the grooved surfaces facing the crankshaft.



Lubricate the parts with engine oil before final assembly.

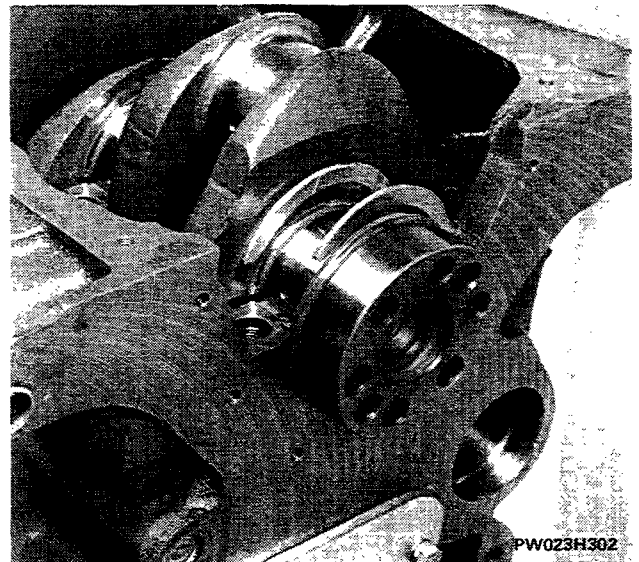

FITTING MAIN BEARING CAPS

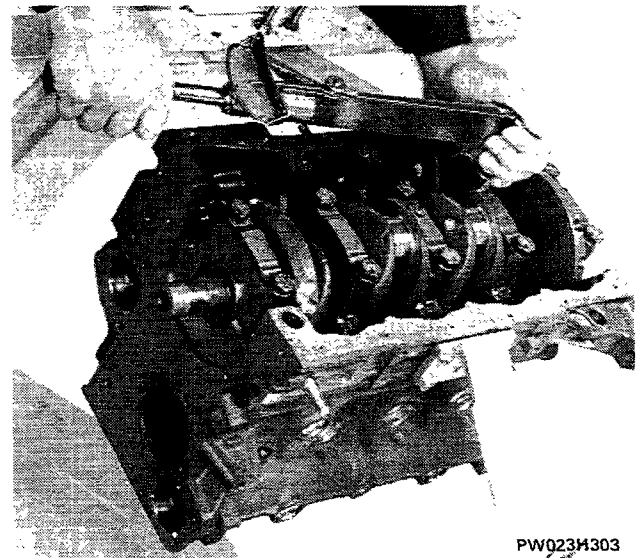

Fitting main bearing caps and tightening the bolts to the correct torque

10.

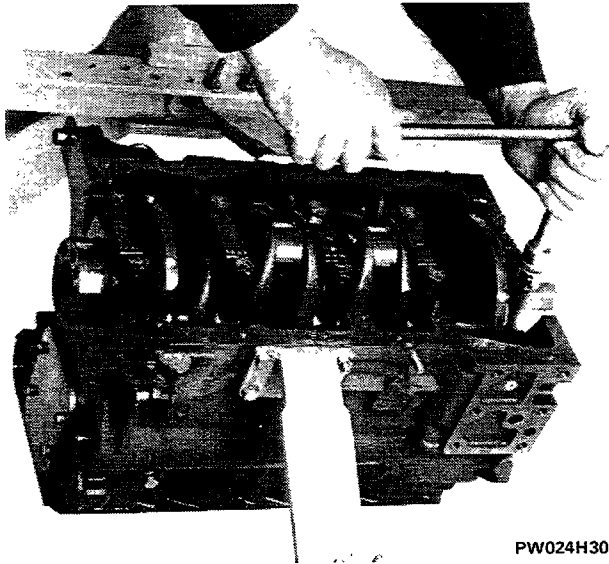

PW024H301



+ 90°

Angle tightening main bearing side caps

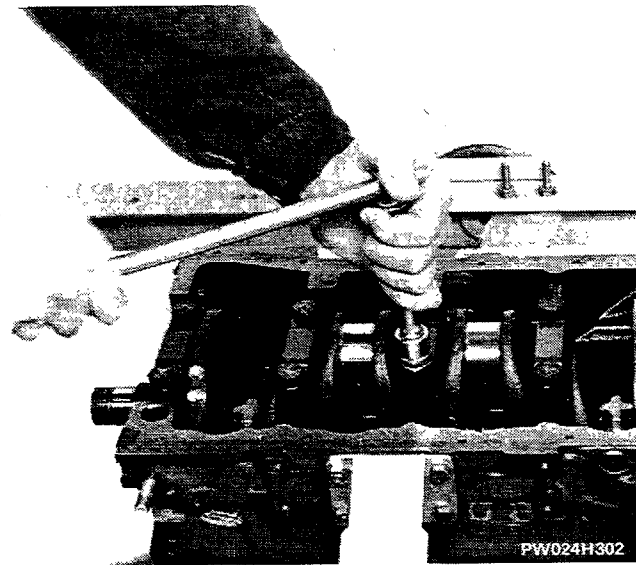

PW024H302



+ 130°

Angle tightening main bearing central caps

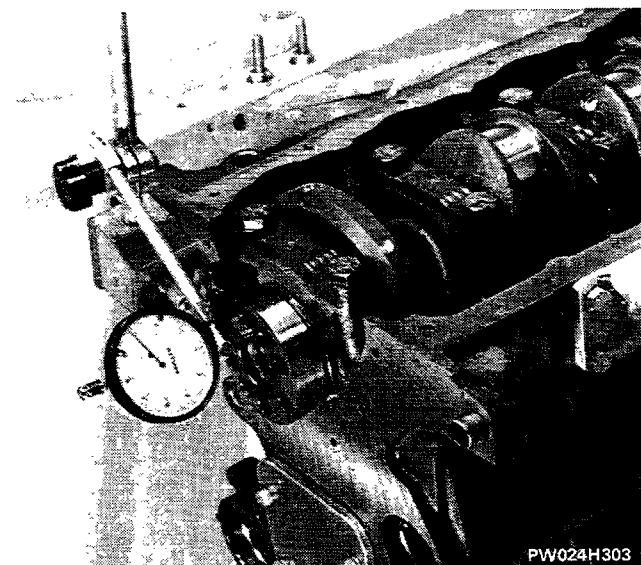

PW024H303



0,055 ÷ 0,305

LANCIA

Checking and measuring crankshaft endfloat

NOTE Replacement thrust washers are available in 0.127 mm oversize.

CRANKSHAFT REAR COVER

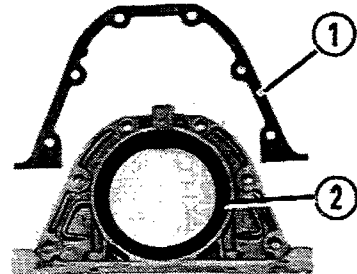

Lubricate the contact surface of the gasket (1) and the lip of the seal (2).

PW025H301

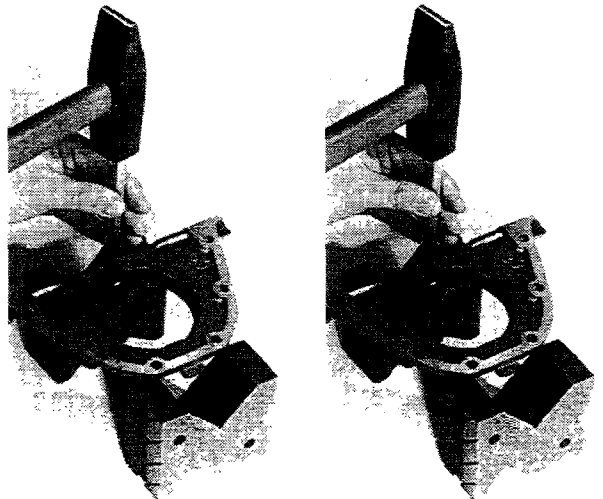

PW025H302

PW025H303

Removing/refitting crankshaft rear oil seal

NOTE *The seal should be removed using a punch inserted in the groove located on the cover inner face.*



PW025H305

PW025H304

Fitting crankshaft rear cover

10.



CRANKSHAFT FRONT COVER WITH INCORPORATED OIL PUMP

NOTE Refer to the Lubrication section for the dismantling and dimensional checking procedures on the oil pump incorporated in the crankshaft front cover.



Before assembly, lubricate the contact surface of the gasket (1) and the lip of the seal (2).

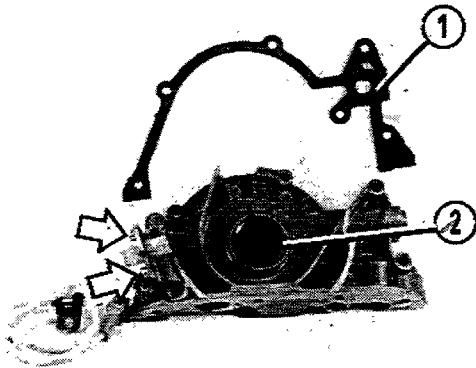

PW026H301

Renewing rpm and TDC sensor

Unscrew the bolts indicated by the arrows and remove the sensor.

Make absolutely sure not to touch the other two bolts, one of which is a shear bolt, which determine the mounting plate adjustment.



Renewing crankshaft front cover or rpm and TDC sensor mounting plate.

Fit the plate on the cover and secure it by its two bolts, one being a shear bolt, without tightening the bolts until the correct position is obtained (see the procedure described on p. 42).



Removing/refitting crankshaft front oil seal

NOTE The seal should be removed using a punch inserted in the groove located on the cover inner face.



Fitting gasket and front cover with incorporated oil pump

NOTE Line up the flat part of the front cover with the oil sump contact surface of the block.

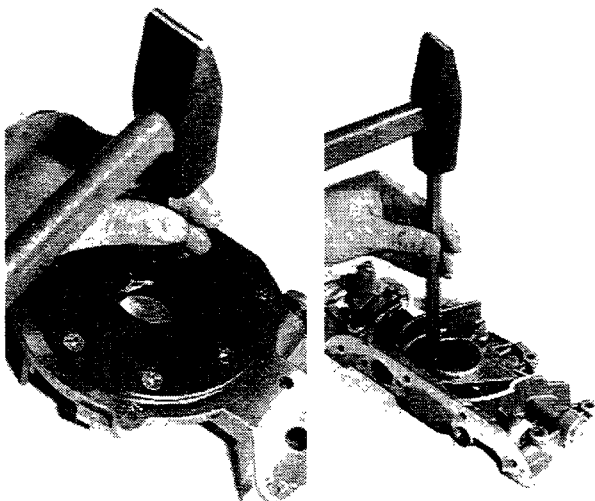

PW026H302

PW026H303

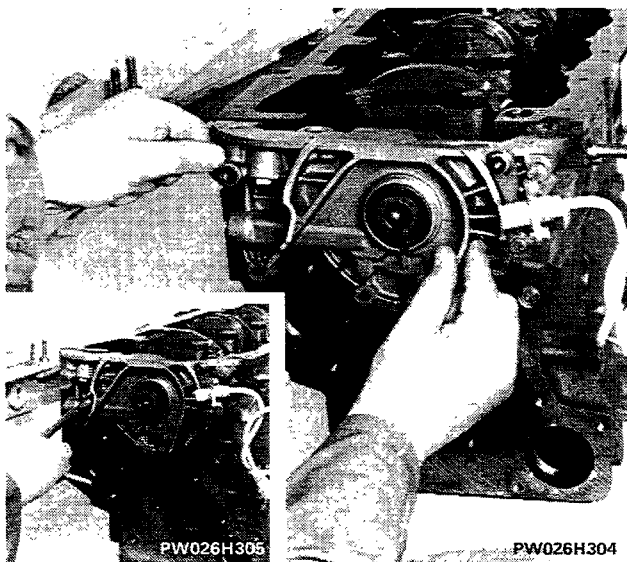

PW026H305

PW026H304

VIBRATION DAMPING SYSTEM WITH COUNTER SHAFTS

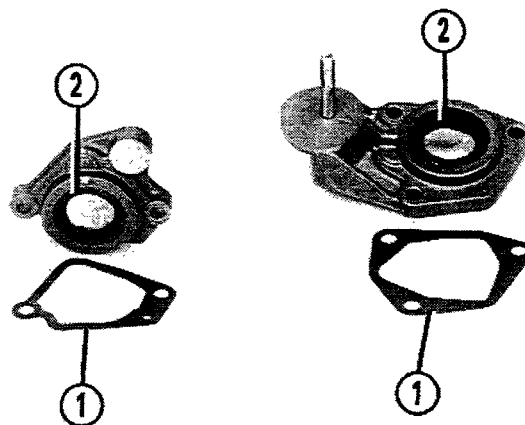

Counter shaft covers



Before assembly, lubricate the contact surface of the gasket (1) and the lip of the seal (2).

PW027H301

PW027H302

Removing/refitting left counter shaft cover seal

NOTE *The seal should be removed using a punch inserted in the groove located on the cover inner face.*

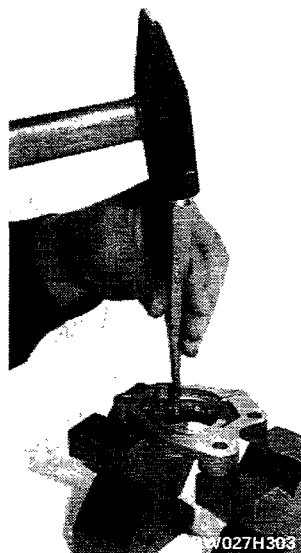

PW027H303

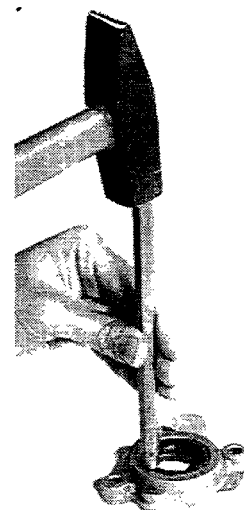

PW027H304

Removing/refitting right counter shaft cover seal

NOTE *The seal should be removed using a punch inserted in the groove located on the cover inner face.*

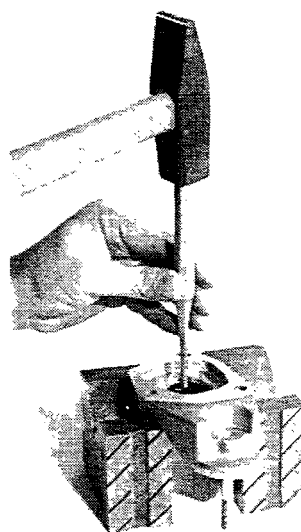

PW027H305

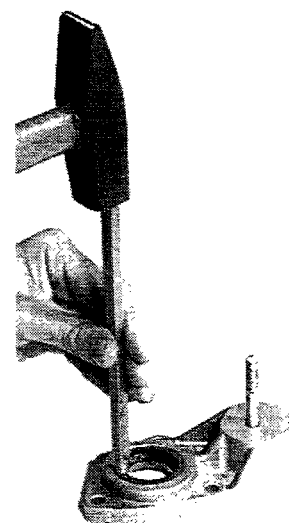

PW027H306

10.

Description of operation

In addition to forces on the piston crowns, caused by expanding gases, the following are present in internal combustion engines:

- centrifugal inertial forces, resulting from the rotating masses;
- 1st and 2nd order alternating forces, resulting from the masses with alternating motion.

The purpose of balancing the engine is to eliminate the vibrations caused by these imbalances during operation.

The imbalances caused by the centrifugal and 1st order alternating inertial forces are eliminated by suitably counterweighting the crankshaft.

The imbalance caused by the 2nd order alternating inertial forces is not usually eliminated in 4 in-line engines; it is left to the engine bearings to partially absorb it.

This engine instead adopts a system which cancels the vibrations caused by these forces; it comprises 2 counter-rotating shafts, with eccentric weights, located in the cylinder block.

The counter shafts are driven by a special double-sided toothed belt and a set of sprockets which enable a speed double that of the crankshaft, and perfect synchrony with the latter, to be obtained.

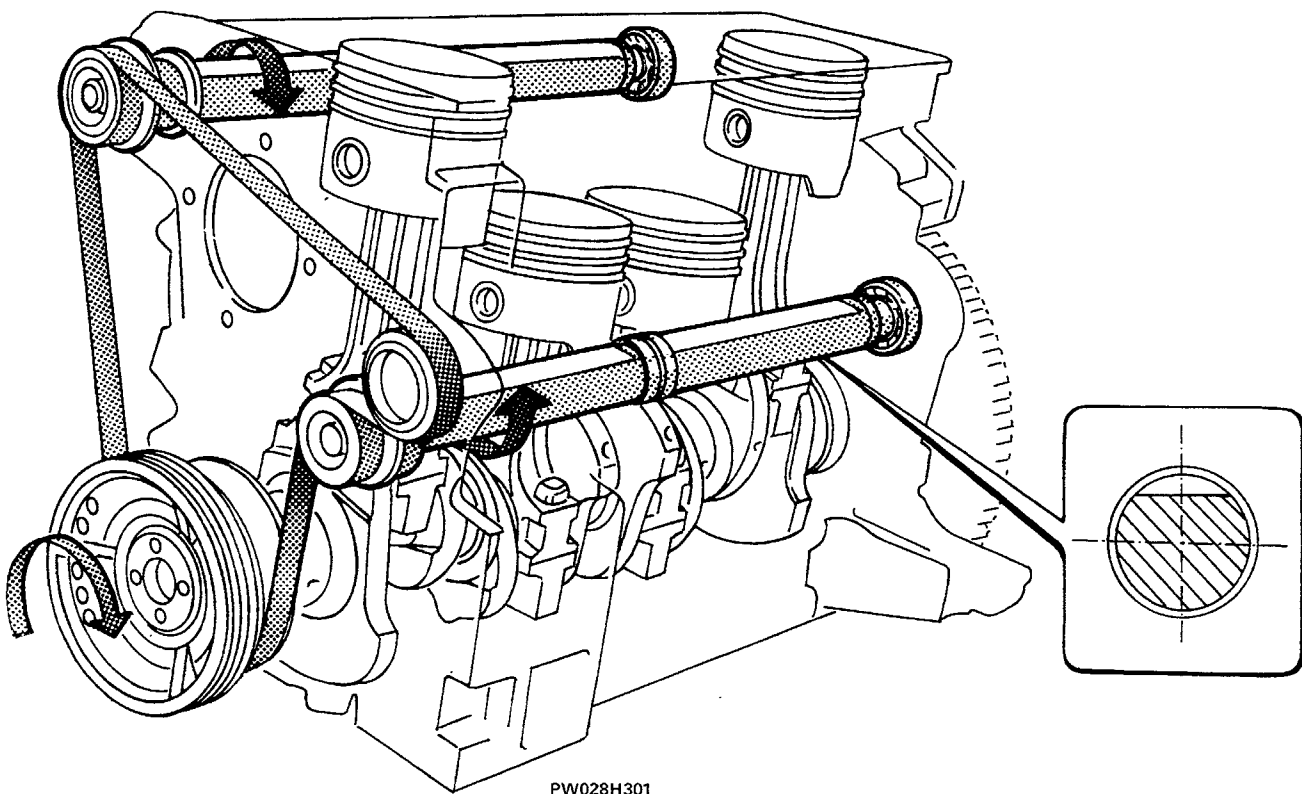

Vibration damping system

Diagram showing the 2nd order alternating inertial forces and the balancing weights in the principal operating positions

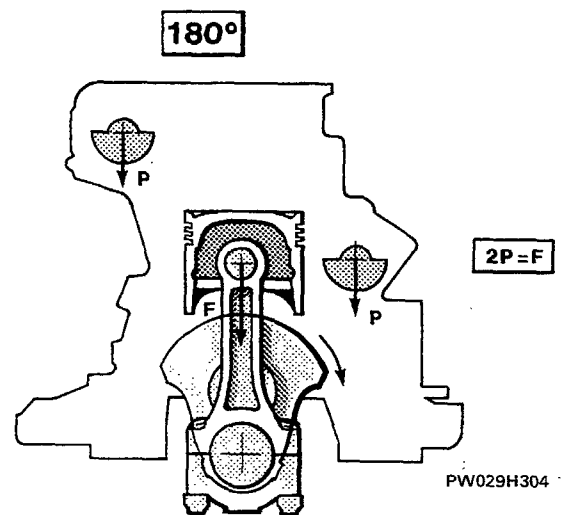
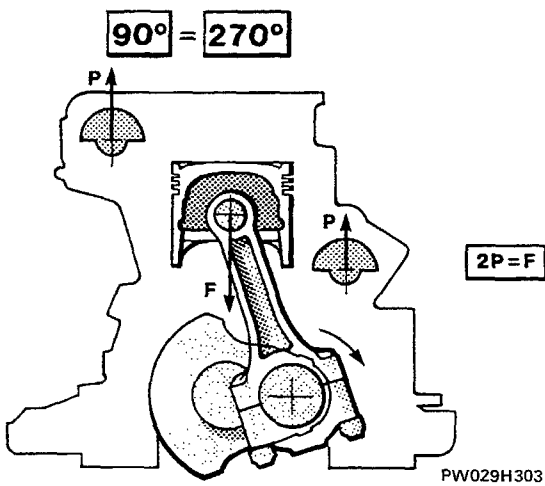
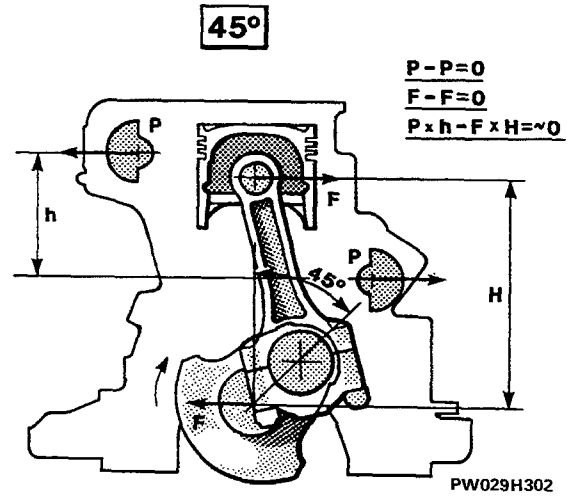
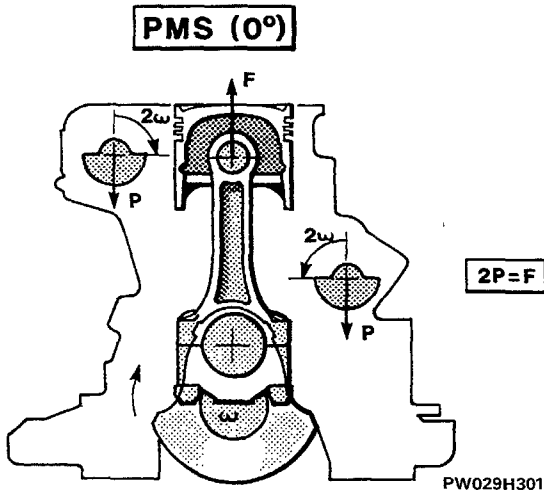

10.

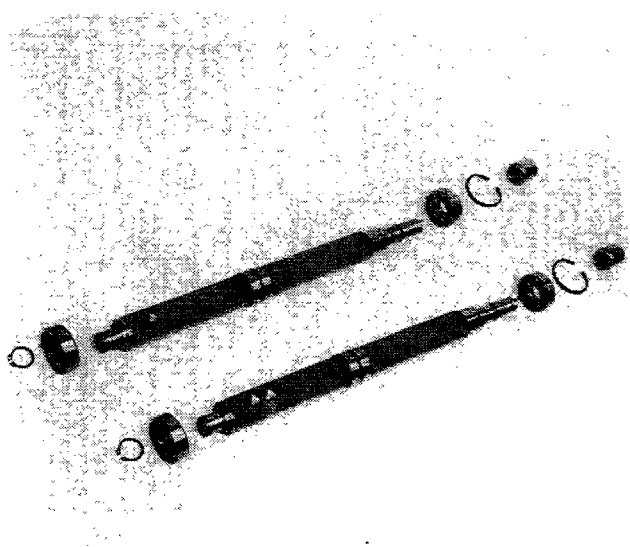

PW030H301

Counter shaft components

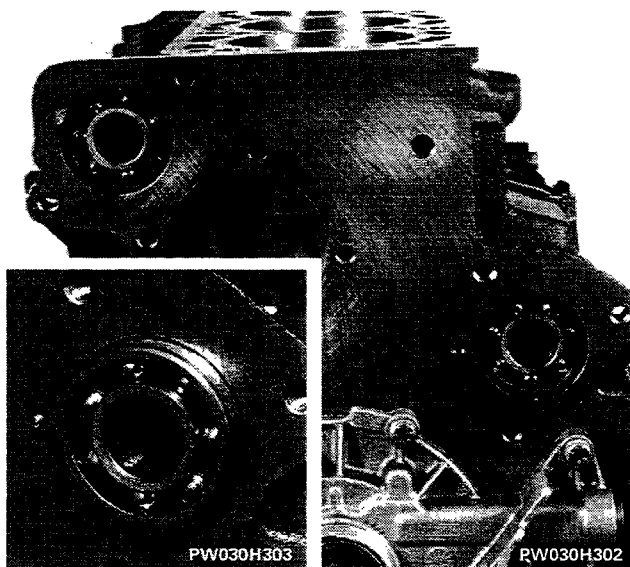

Fitting counter shafts

Refit the counter shafts in the cylinder block as follows:

- install the bearings on the timing gear side in their locations, using a suitable drift;

NOTE *The detail photo shows a bearing positioned in its location, before final assembly in the block.*

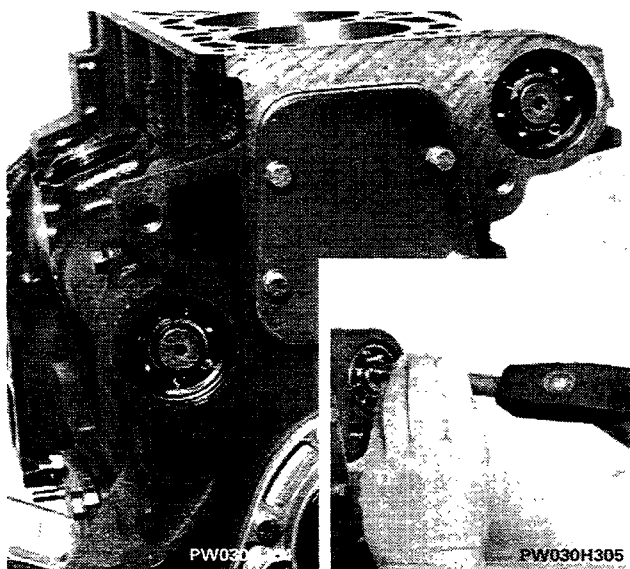

- fit the counter shaft assemblies from the flywheel side, using a suitable drift;

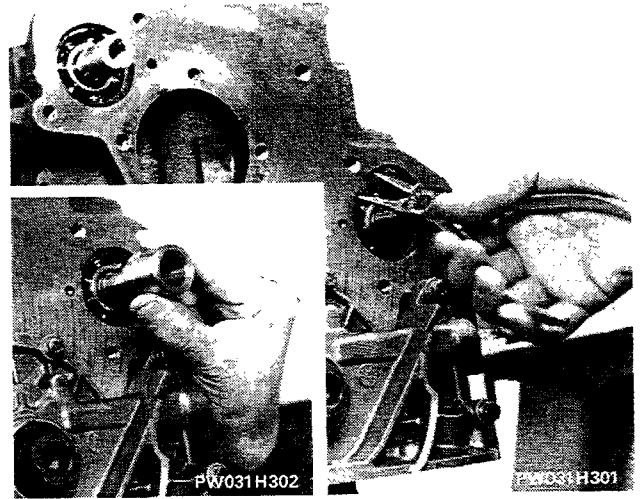

- fit the bearing circlips in their locations (timing gear side):
- fit the spacer bush as shown in the detail photo:

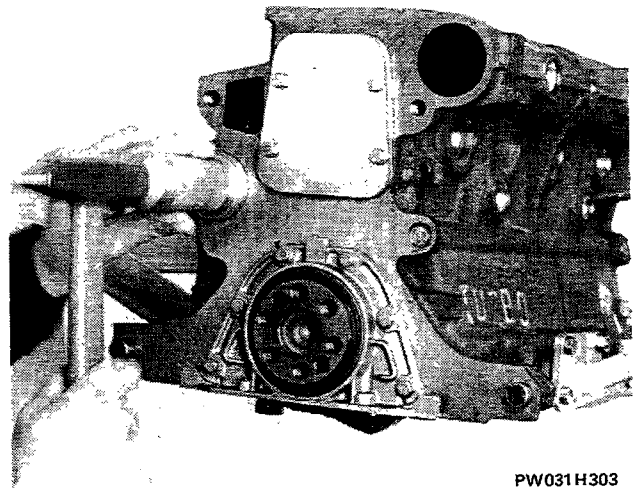

PW031H303

- install the counter shaft covers using a suitable drift (flywheel side).

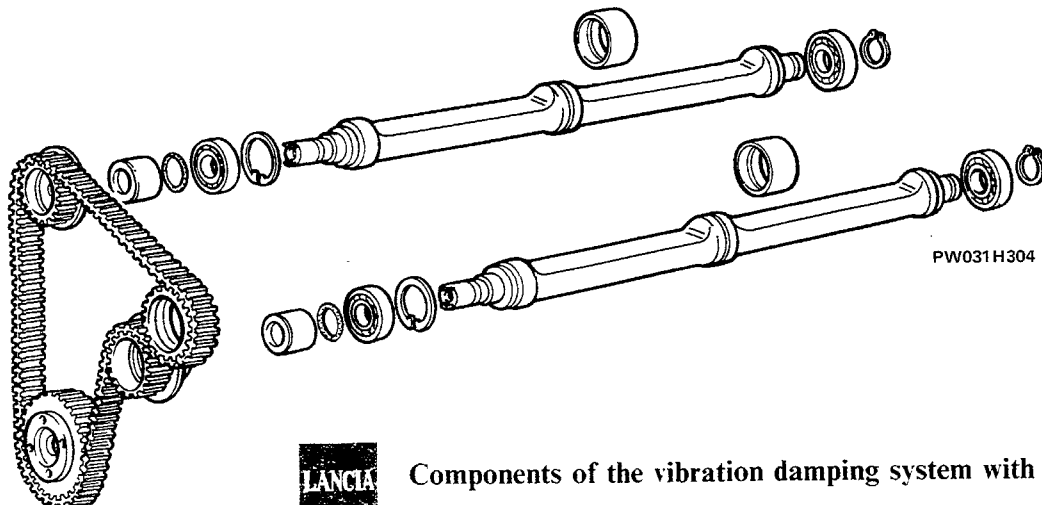

PW031H304



Components of the vibration damping system with counter shafts

10.



FLYWHEEL

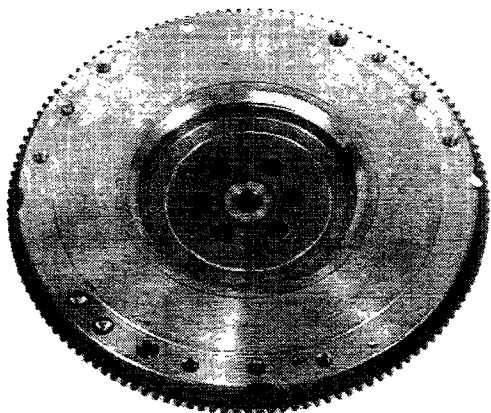

PW032H301

Checking clutch plate contact surface

If the surface is scored, it should be skimmed.

NOTE To replace the flywheel starter ring, preheat the new ring in an oven at 80 °C and press it onto the flywheel with the bevel on the inner diameter facing the flywheel. To remove, use an ordinary steel drift.

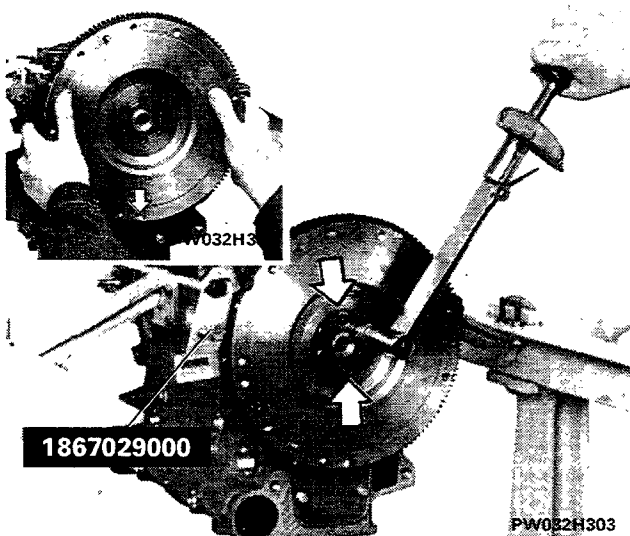

1867029000

PW032H303



Fitting flywheel and tightening bolts to correct torque

NOTE Turn the crankshaft until the crankpins of cylinders 1 and 4 are at TDC position, shown by the arrow in the detail photo, facing the cylinder head support surface.

Mount flywheel locking tool 1867029000.



Tighten only four bolts to torque, leaving two diametrically opposed holes, as shown by the arrows, for fitting the flywheel rotating tool 1860744000. The remaining two bolts should be fitted and tightened to torque after the flywheel rotating tool has been removed at the end of the engine reassembly procedure.

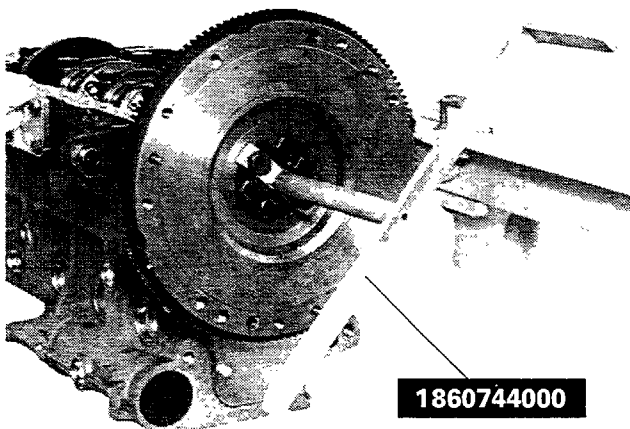

1860744000

PW032H304

Fitting flywheel rotating handle

The flywheel locking tool 1867029000 should be removed.

PISTON / CONNECTING ROD ASSEMBLY



Removing piston rings

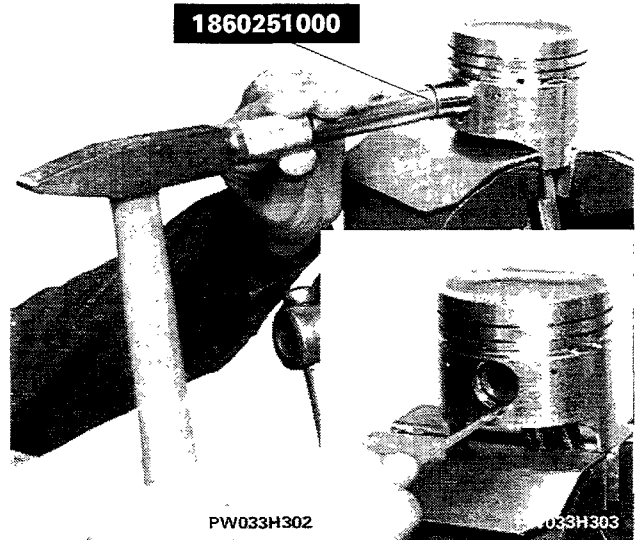

Removing gudgeon pin

NOTE *The parts may be reused if they are undamaged; however, the components must be marked ensure that they are refitted in their original assemblies.*

PISTONS

Measuring piston diameter

Standard: graded like the cylinder bores into five 0.01 mm categories:

A, B, C, D and E

As spares: A, C and E only.

Oversize:

0.4 mm

with no diameter or category grading for the gudgeon pin boss holes.

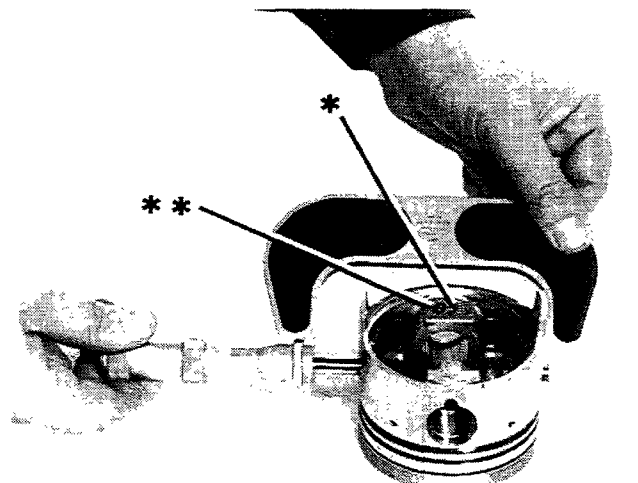

* Number indicating the gudgeon pin category

** Letter indicating the piston grade

10.



Cleaning piston crown

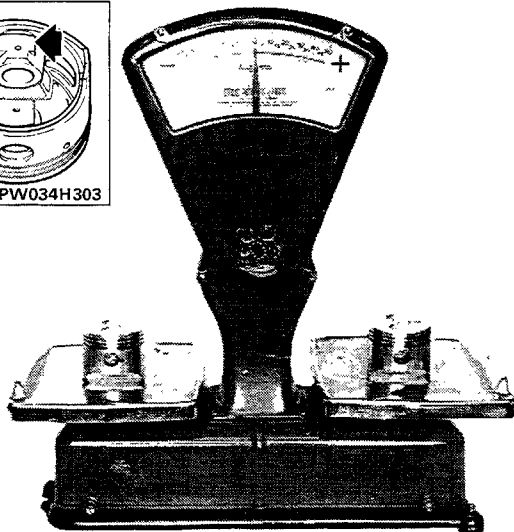
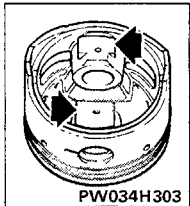

± 5 g



Checking piston weight imbalance

NOTE *The arrows show the areas from where material should be removed to obtain weight balance.*

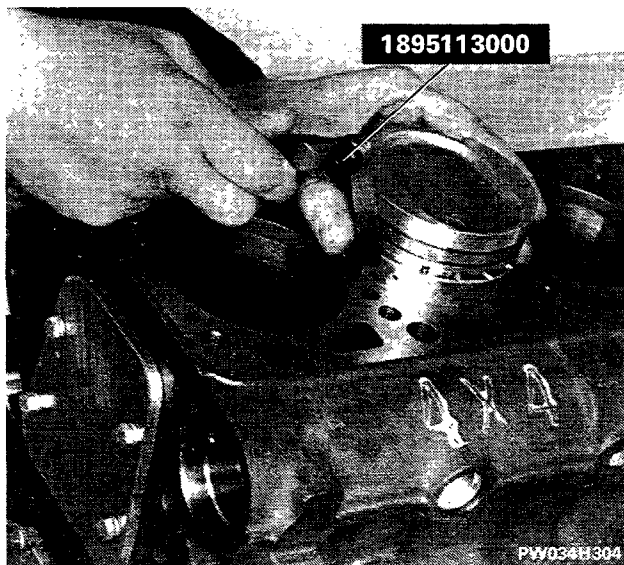

0.075 - 0.170

Checking clearance between piston and cylinder bore

GUDGEON PINS

\varnothing_1	21,991 ÷ 21,994	
\varnothing_2	21,994 ÷ 21,997	

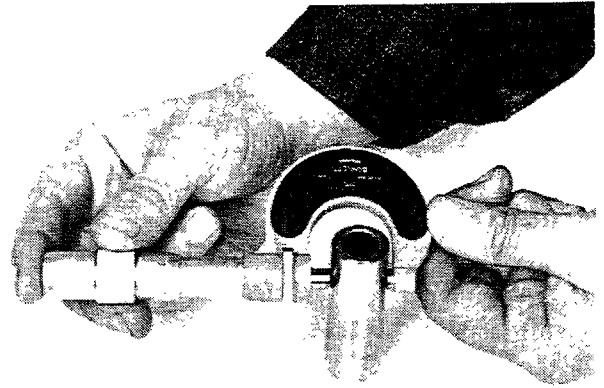

Measuring diameter

Standard pins are graded into categories to match the piston bosses.

NOTE Replacement gudgeon pins are also available with 0.2 mm oversize diameter.

PW035H301

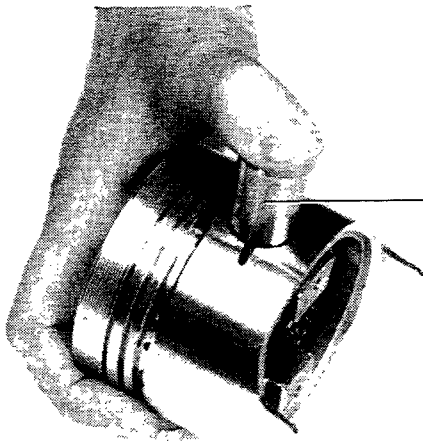

The pin must be a simple thumb push fit.

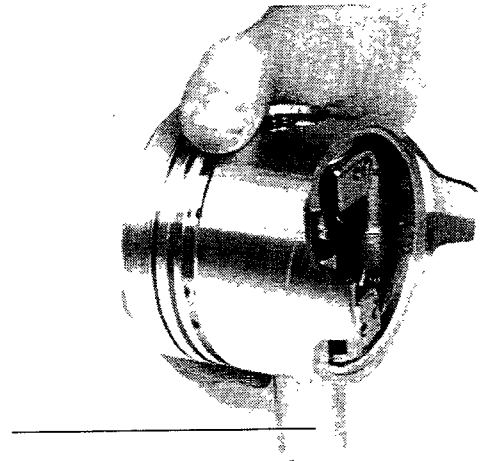

PW035H302

It must not fall out under its own weight.

PW035H303

Conditions for correct piston/gudgeon pin match

PISTON RINGS

1	1,478 ÷ 1,490	
2	1,978 ÷ 1,990	
3	3,925 ÷ 3,937	

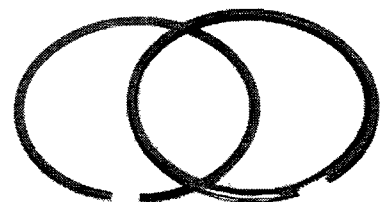
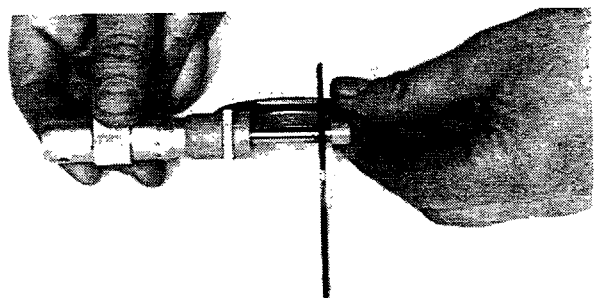

Measuring piston ring thickness

PW035H304

10.

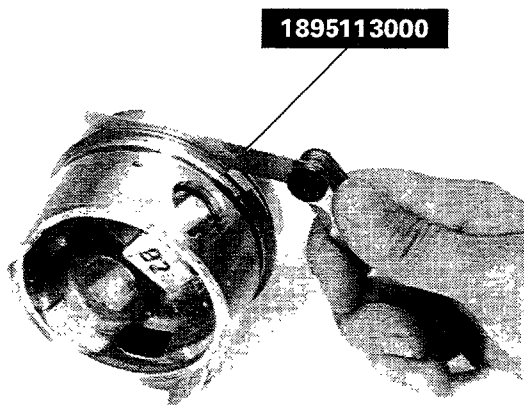

PW036H301



1	0,045 ÷ 0,077
2	0,040 ÷ 0,072
3	0,030 ÷ 0,062

Checking clearance between piston rings and grooves

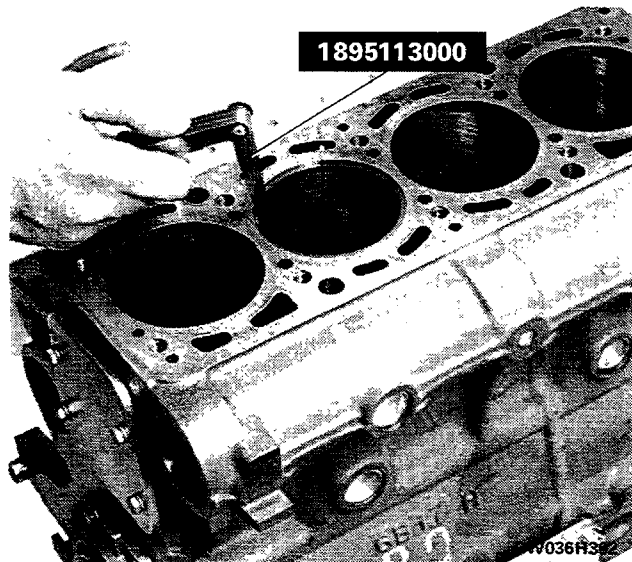

PW036H302



1	0,030 ÷ 0,045
2	0,030 ÷ 0,045
3	0,025 ÷ 0,040

Checking and measuring piston ring end gaps

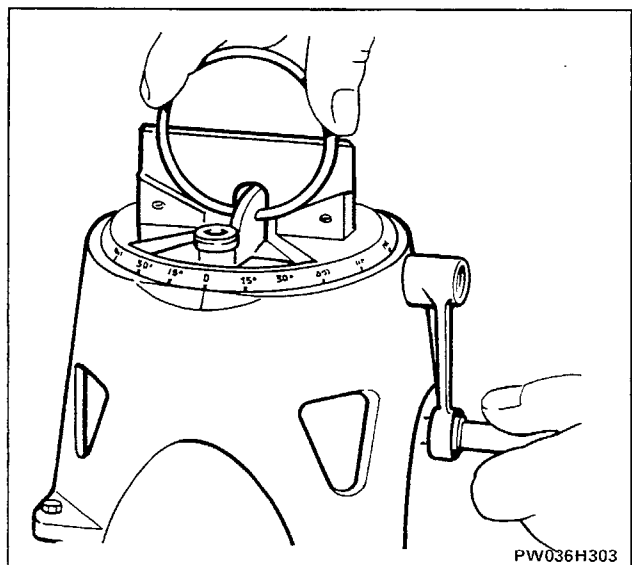

PW036H303



Recutting piston ring ends

Replacement piston rings are also available in 0.4 mm oversize.

CONNECTING RODS

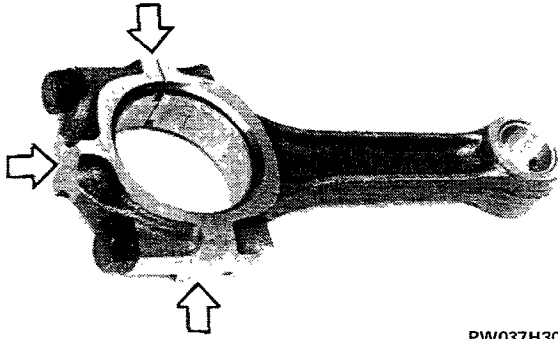

PW037H301

Checking connecting rod weight imbalance

The arrows show the areas from where material may be removed to obtain connecting rod weight balance.

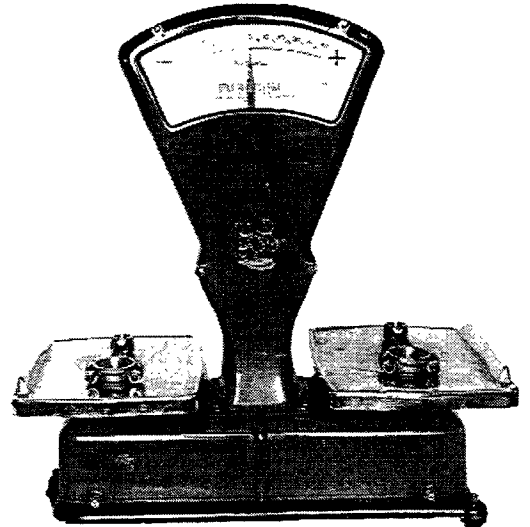

PW037H302

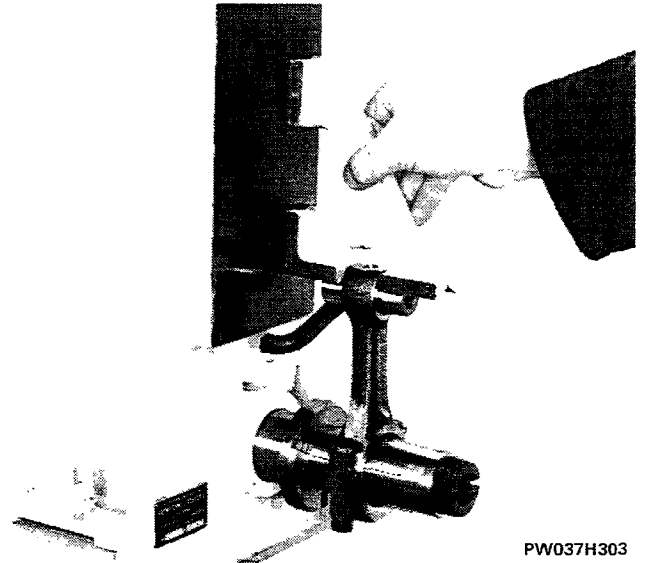

PW037H303

Checking connecting rod alignment

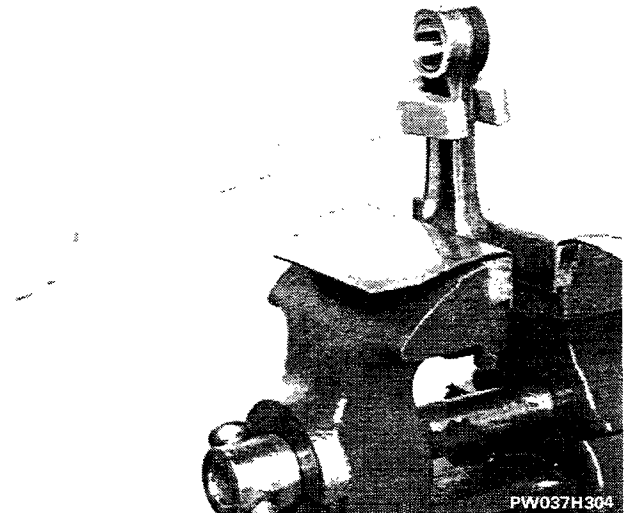

PW037H304

Straightening connecting rod stem

10.

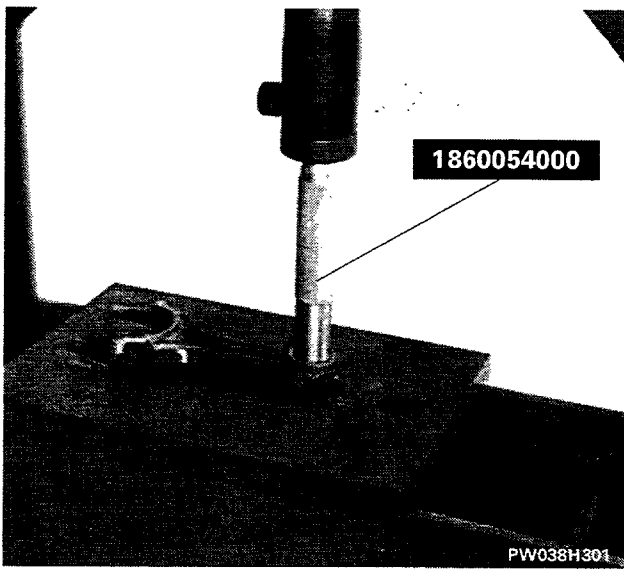

SMALL END BUSHES

Removing/refitting small end bush

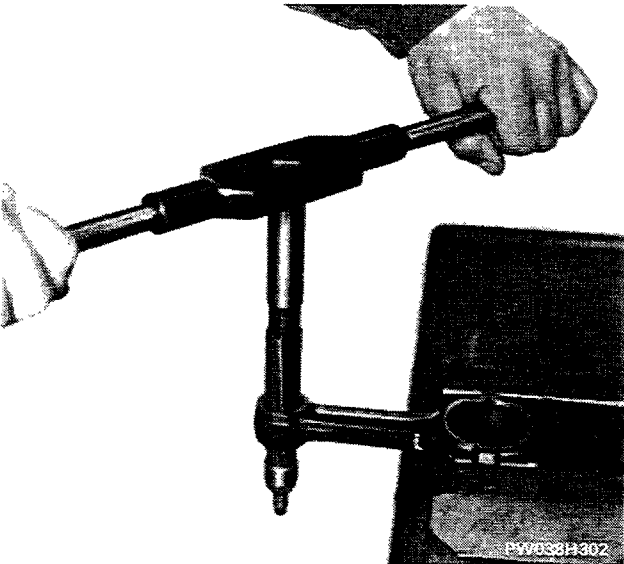

Reaming bush installed in small end

FITTING PISTON/CONNECTING ROD ASSEMBLY

Piston/connecting rod match

The piston should be fitted so that the arrow (2000 i.e. turbo engine) or smaller recess (2000 i.e. engine) on the crown is on the side opposite that where the cylinder number is engraved on the connecting rod.



If the connecting rod is replaced, the number of its corresponding cylinder should be stamped on the side opposite that of the bearing shell retaining notches.

* Number of connecting rod's corresponding cylinder

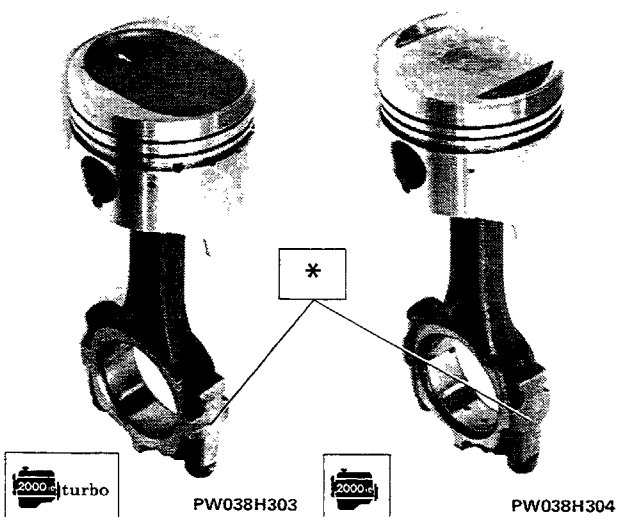



1860251000

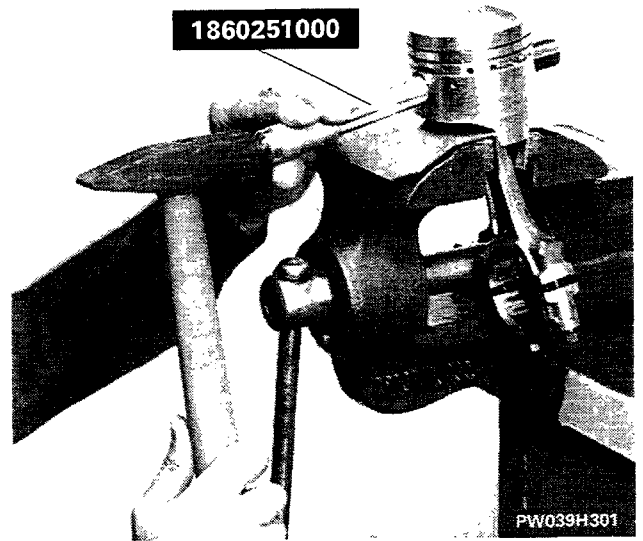

PW039H301

Fitting gudgeon pin in piston/connecting rod assembly



1860303000

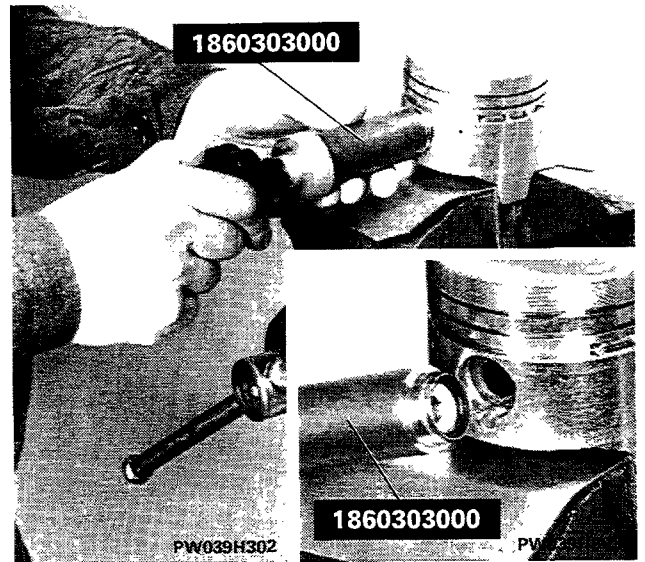

PW039H302

1860303000

PW

Fitting gudgeon pin circlips



1860183000

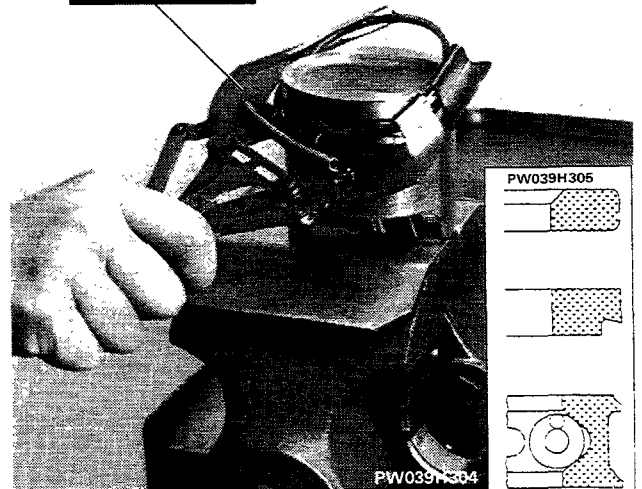

PW039H305

PW039H304

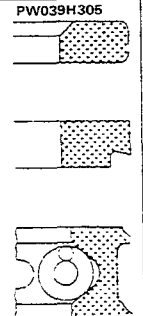

Fitting and positioning piston rings

The piston rings should be fitted with the word "TOP" uppermost.

After assembly, position the piston ring end gaps so that they are staggered by approximately 120°.

10.

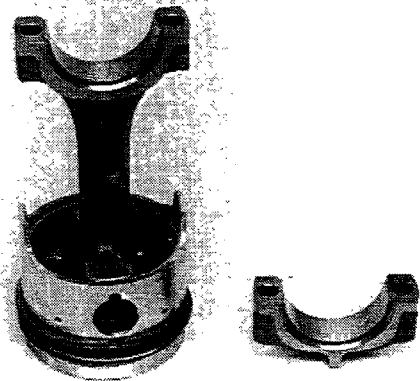

PW040H301



BIG END BEARINGS

Fitting big end bearings

NOTE *Big end bearings are available in under-sizes of 0.254 and 0.508 mm.*



Do not attempt to make good the bearing shells. Ensure that the connecting rod location is not out of round; if it is, renew the faulty connecting rod. Thoroughly clean the outer surfaces of the bearings shells and their locations just before assembly.

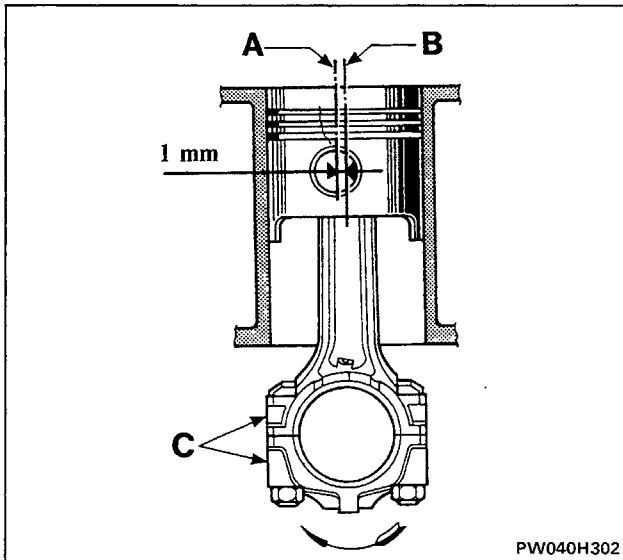

PW040H302



Diagram of piston/connecting rod assembly and orientation in engine

The arrow on the piston crown should face the exhaust manifold side (2000 i.e. turbo engine).

The smaller recess on the piston should be on the exhaust manifold side (2000 i.e. engine).

- A. Axis of cylinder
- B. Axis of connecting rod
- C. Area for stamped number of connecting rod's corresponding cylinder bore

NOTE *The arrow shows the direction of rotation of the engine viewed from the timing gear side.*

PW040H303

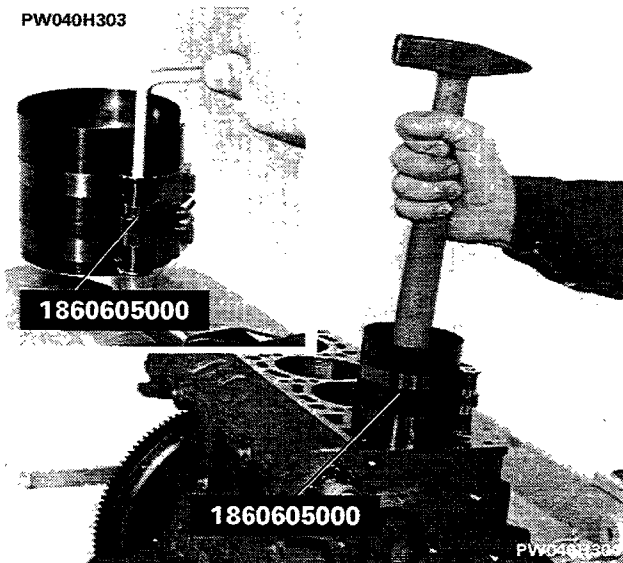

Installing piston/gudgeon pin/connecting rod assembly in cylinder bore



Lubricate the parts with engine oil before final assembly.

MEASURING CRANKPIN RUNNING CLEARANCES

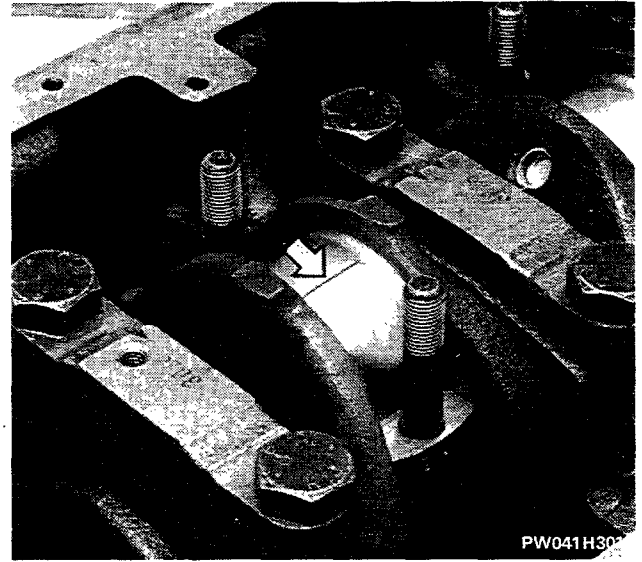

Using calibrated filament (Plastigage) to measure the crankpin running clearances

The arrow shows the calibrated filament

2.5 daNm + 50

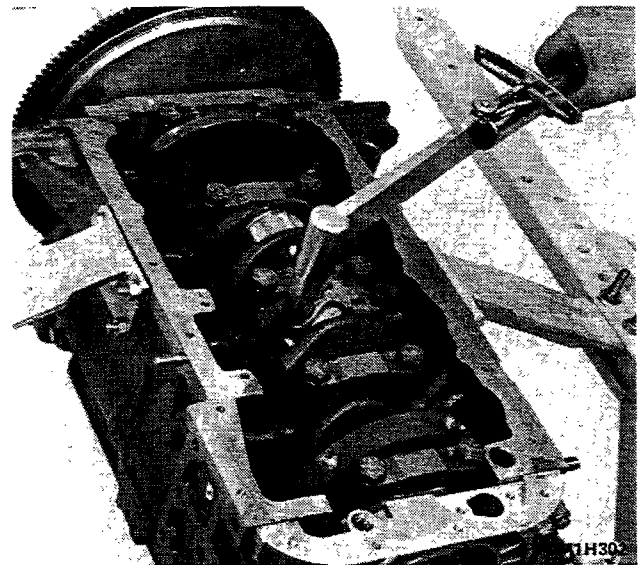

Tightening big end bearing cap bolts to correct torque



0.029 = 0.053



0.025 = 0.049

2.5 daNm + 50

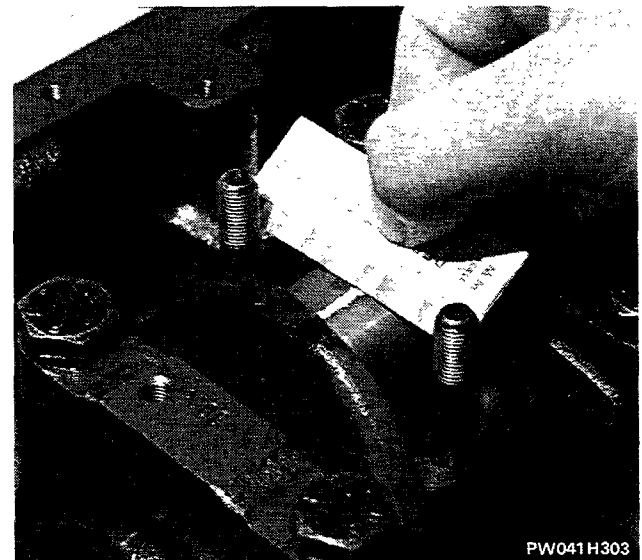

Measuring crankpin clearances using a special gauge



Lubricate the parts with engine oil before final assembly.

Tighten the big end bearing cap bolts to the correct torque

10.

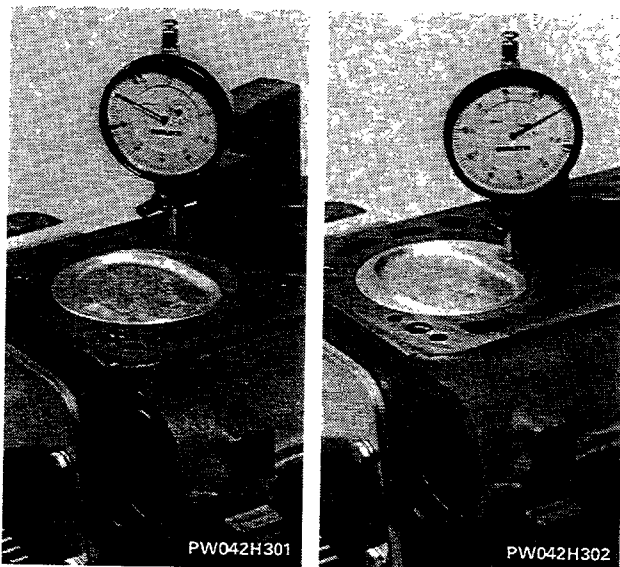

POSITIONING TDC AND RPM SENSOR MOUNTING PLATE



This procedure should be carried out whenever the sensor mounting plate or front cover are separated or replaced.

Obtain the correct sensor mounting plate position as follows:

- place the dial indicator 1895882000 with its mounting 1870404000 on the cylinder block top face at cylinder n°1, then reset the indicator with the indicator probe in contact with the cylinder block top face.
- bring the probe level with the crown of piston n°1 and turn the flywheel until the piston reaches TDC. The TDC position is reached when the indicator is reset.

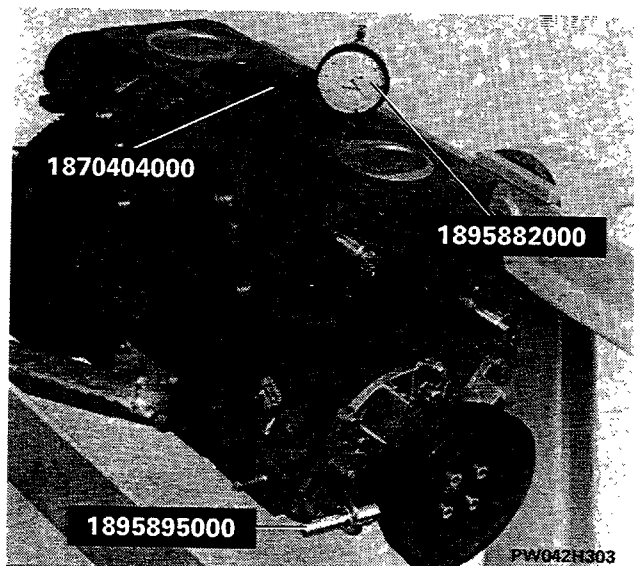

- fit tool 1895895000 onto the mounting plate in place of the sensor, using the sensor's bolts, and check that its end groove fits perfectly over the lug on the inner edge of the crankshaft sprocket, as illustrated in the detail.

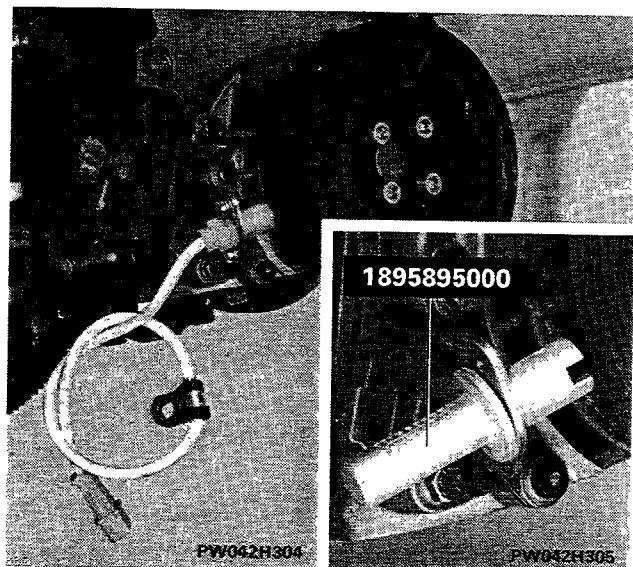

The tool should fit without being forced; if not, slacken the plate's bolts and move the plate until allows easy fitting of the tool. Only then should the plate's bolts be tightened until the head of the shear bolt breaks, to prevent subsequent tampering. Remove tool 1895895000 and install the rpm and TDC sensor in its place.

DISMANTLING CYLINDER HEAD

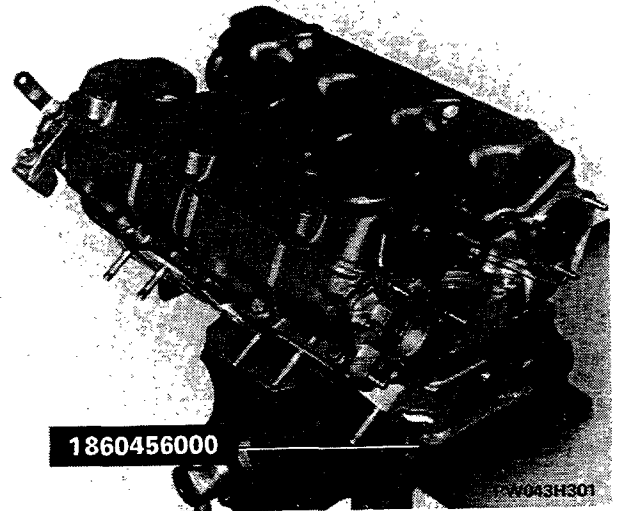

1860456000

PW043H301

Mounting cylinder head, complete with upper heads, on tool 1860456000

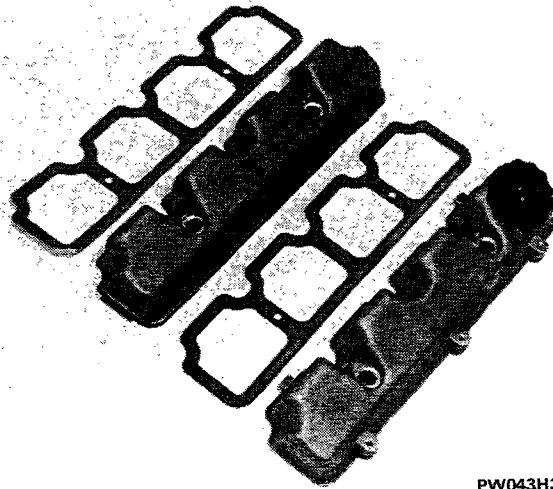

PW043H302

Removing rocker covers

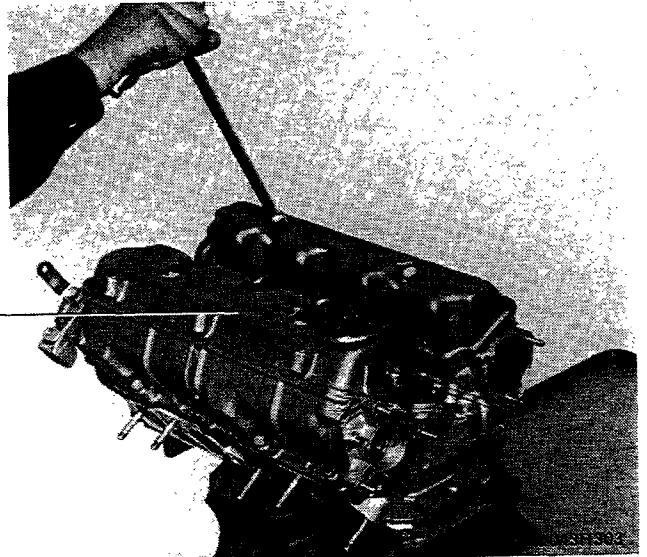

LANCIA



PW043H304

Removing/refitting knock sensor on cylinder head

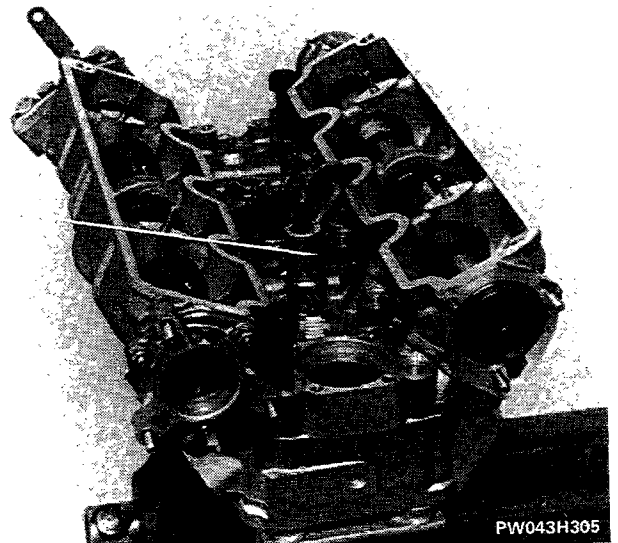

PW043H305

10.

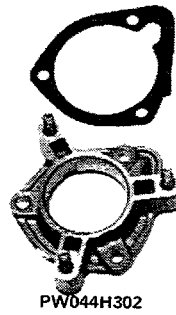
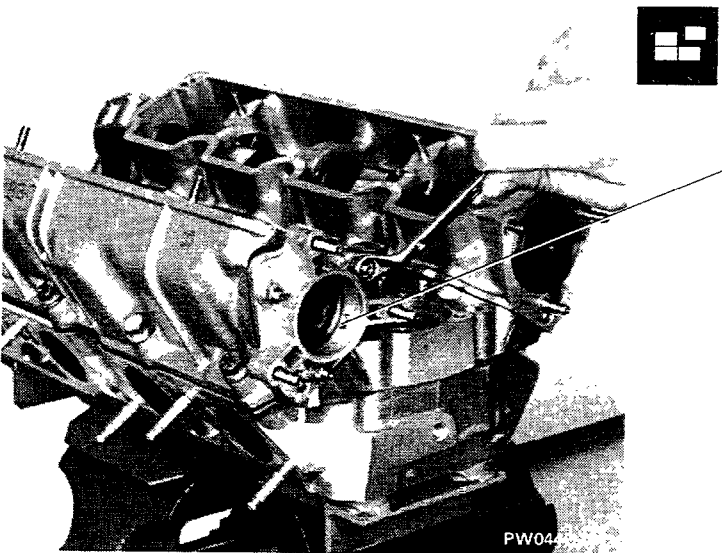

Removing distributor mounting

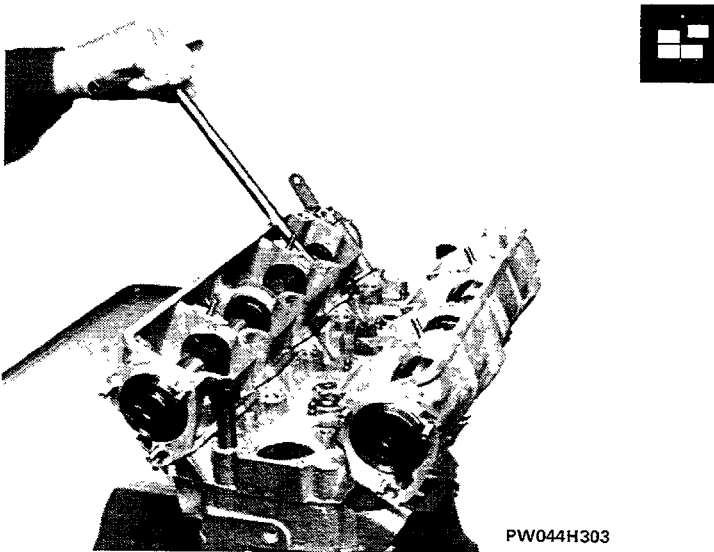

Removing upper heads from cylinder head

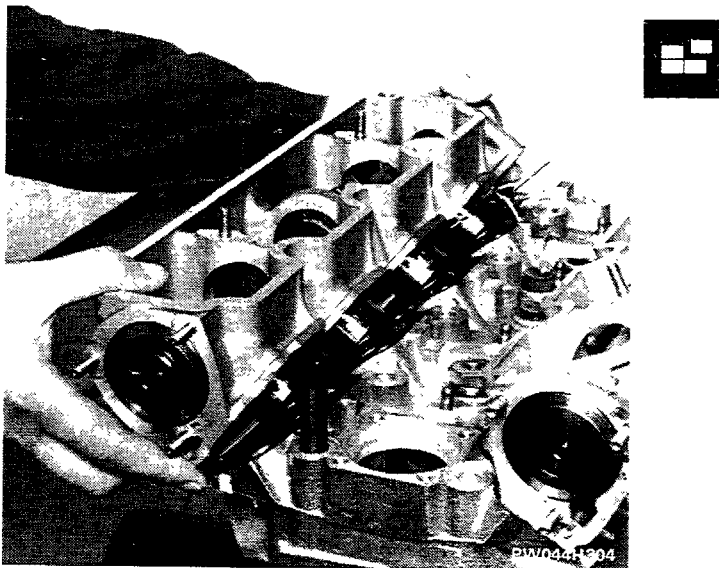

Separating upper heads from cylinder head

NOTE Turn the upper head outwards to prevent the tappets from slipping out of their locations

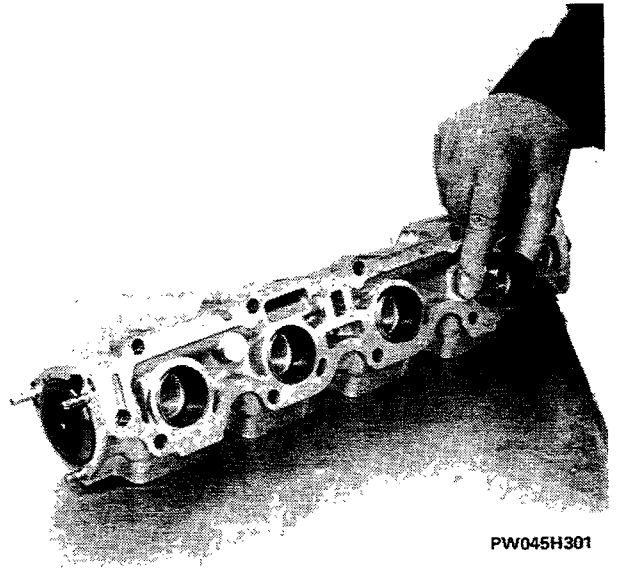

PW045H301

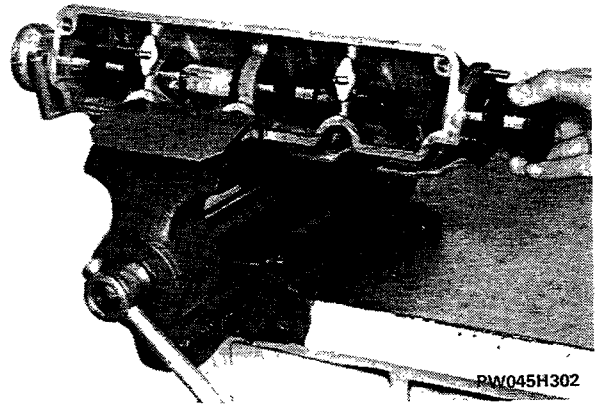

PW045H302

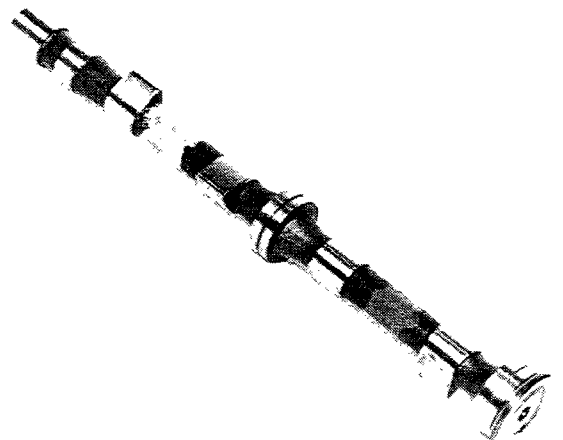

PW045H303

Removing tappets

Removing camshaft

Camshaft

10.

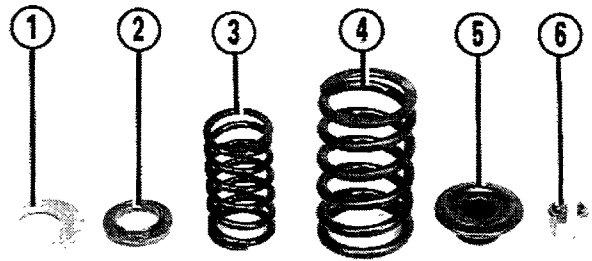
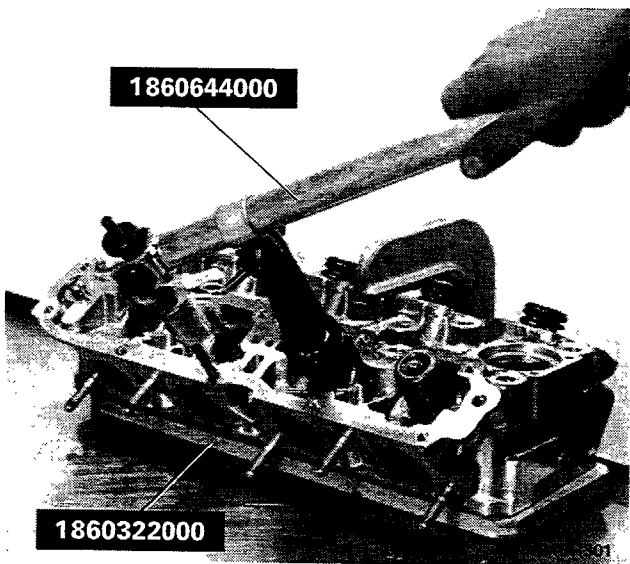

PW046H302

1. Plain washer
2. Bottom cap
3. Inner spring
4. Outer spring

5. Top cap
6. Split taper collets

Dismantling split collets, caps, springs, valves

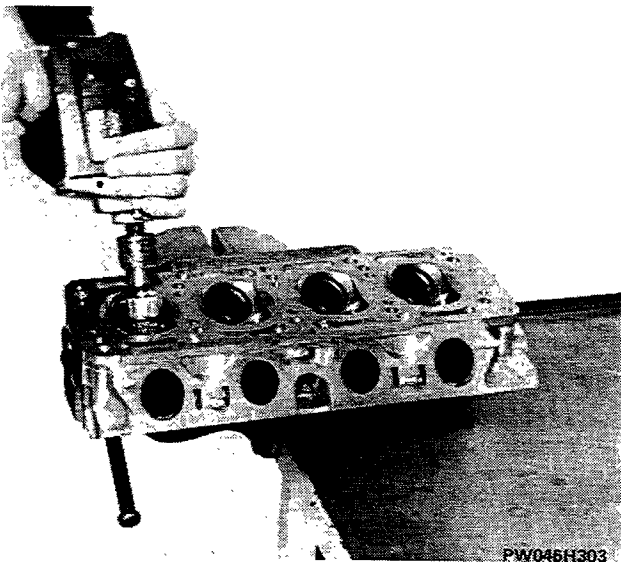

PW046H303

Decarbonizing and cleaning valve seats and passages

Measuring combustion chamber volume

After refacing the cylinder head, check the combustion chamber volume (2000 i.e. turbo: 47.7 cm³; 2000 i.e.: 48.4 cm³) as follows:

- fit the valves and spark plugs;
- fill a measuring cylinder with VS 20 or 30 engine oil;
- leave the oil to stand in the cylinder for approximately 10 minutes;
- note the amount of oil put in;
- place a glass plate on the head with holes over the combustion chambers as illustrated;
- completely fill the combustion chamber, taking care not to spill oil outside the hole;
- wait approximately 10 minutes to allow the oil to settle in the cylinder;
- measure the amount of oil remaining and calculate the difference between the contents of the cylinder before and after filling the chamber: the resulting value corresponds to the volume of the chamber.

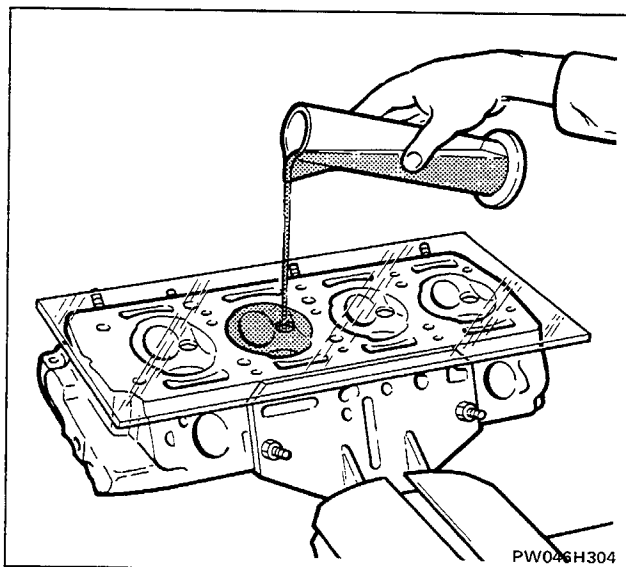

PW046H304

Areas for removal of material

If the volume is below the specified value, material should be removed from inside the chamber until the value is correct.

NOTE *The arrows show the areas for removal of material.*

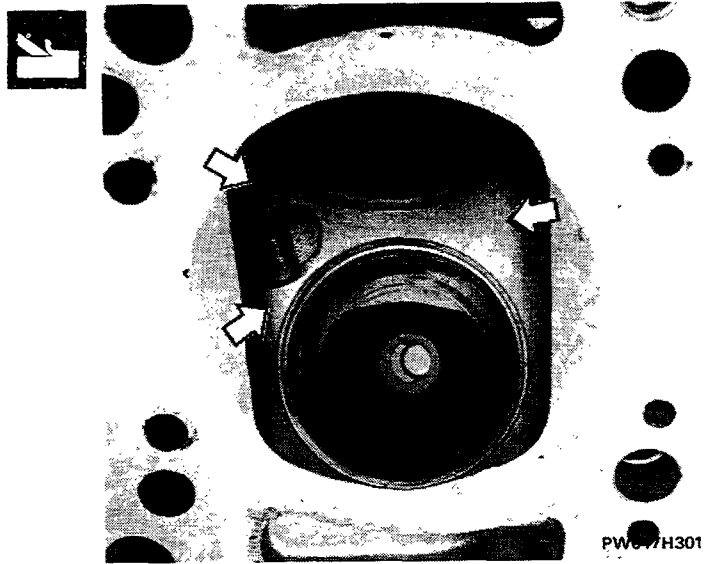

VALVES

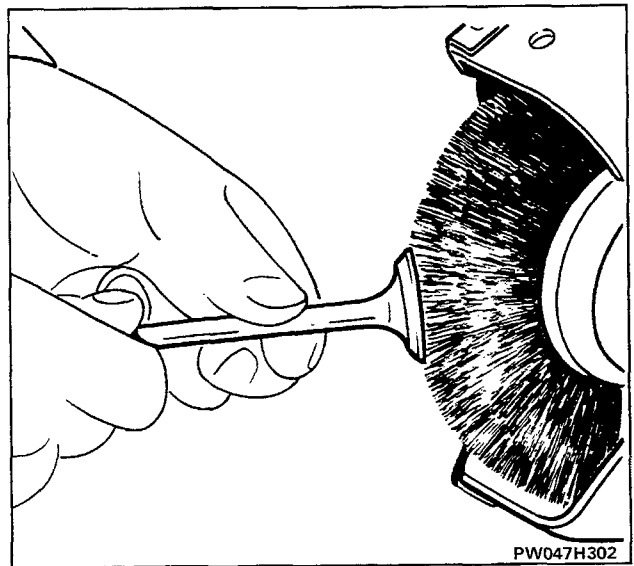
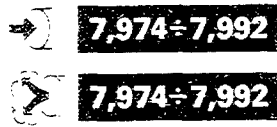

Decarbonizing and checking valves

Check that the valve stem does not show signs of seizure or scoring; also check, using a micrometer, that the valve stem diameter is within the tolerance limits.

Valve recutting using a grinder

Set the scale to 45° 30' and recut the valve head, removing as little material as possible. If the top of the valve stem is pitted, regrind it, again removing as little material as possible.

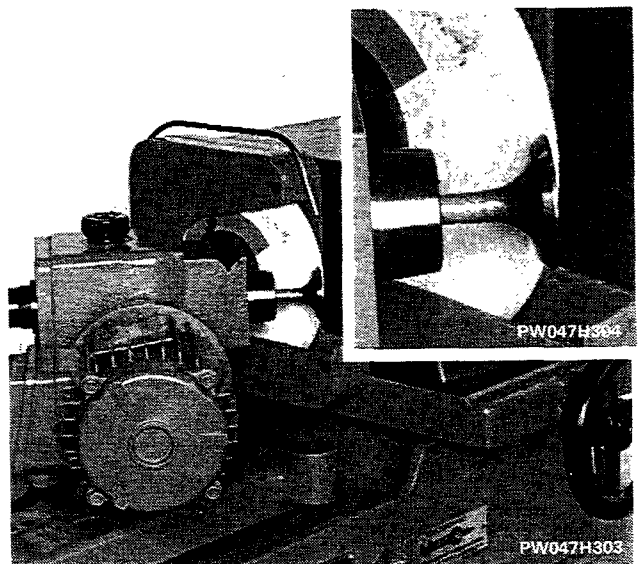

It is advisable to renew the valves rather than to regrind them.

10.

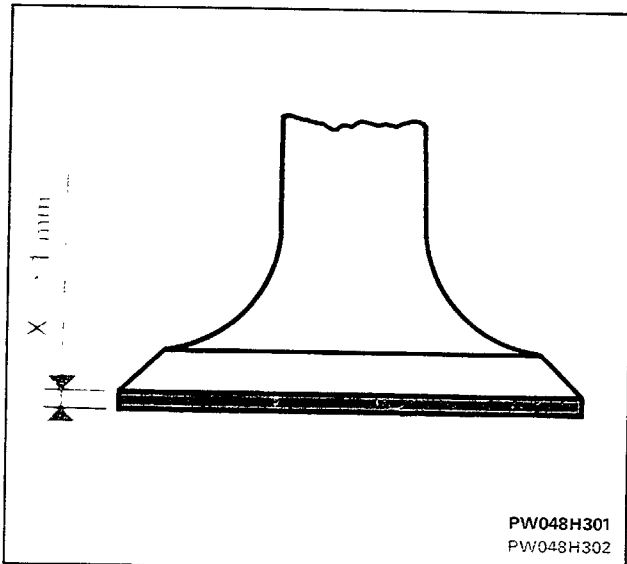

≥ 1

Checking dimension (X)

After recutting, check that the thickness (X) of the valve head edge is at least 1 mm, otherwise the valve will need to be renewed.

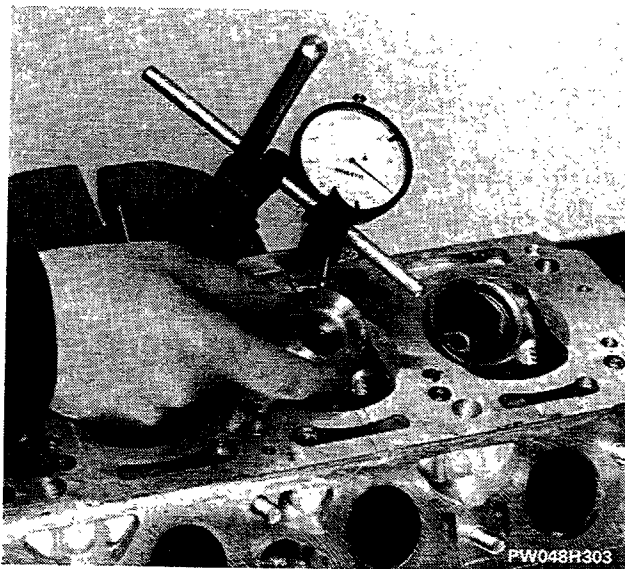

Checking clearance between valve stem and valve guide

NOTE If the clearance (measured as illustrated) between the valve stem and valve guide is over 0.25 mm, the valve guide should also be renewed.

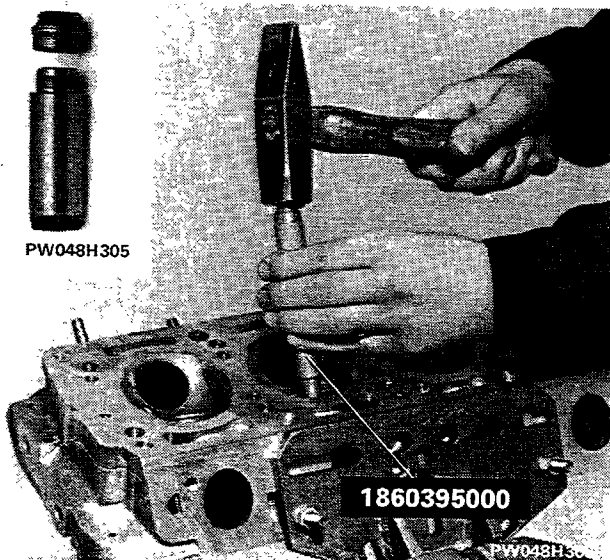

VALVE GUIDES

Removing valve guide

Fitting valve guide

Replacement valve guides are also available in external diameter oversizes of 0.10, 0.20, 0.25 and 0.45 mm.

NOTE *Before fitting the new valve guides, heat up the cylinder head to 100 - 120 °C.*

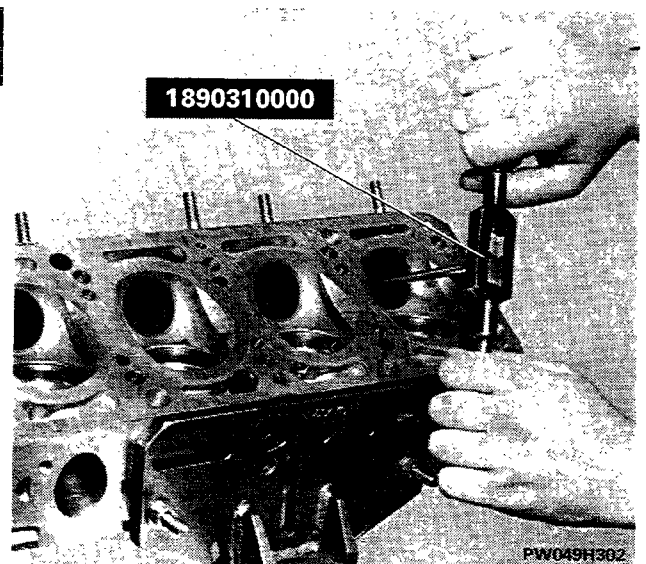

Reaming valve guide inner surface

This should be done if slight distortion occurs during installation.

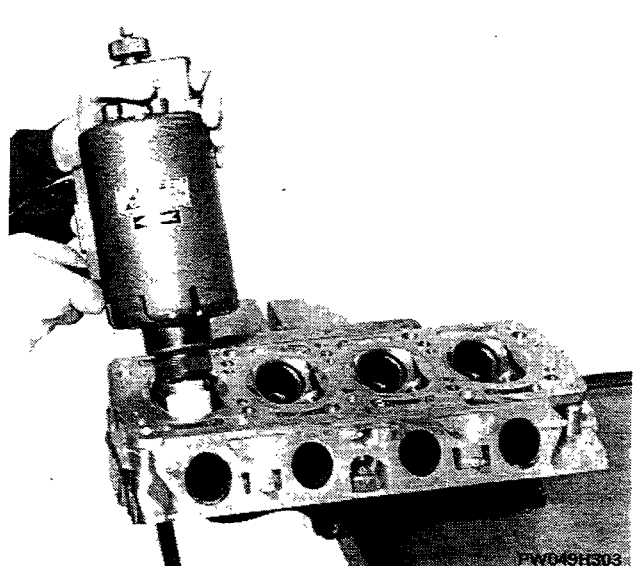

Regrinding valve seats in cylinder head

NOTE *The valve seats in the cylinder head should be reground whenever the valves or valve guides are reground or renewed.*

10.

W = Valve seat recut at 45° and reduced to the specified width.

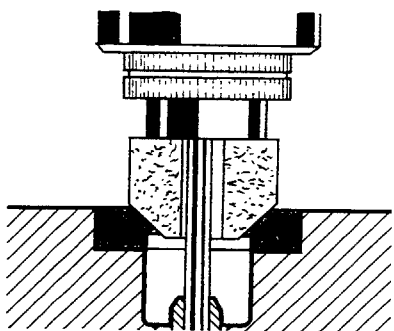
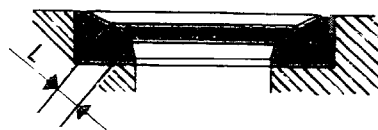

Regrinding valve seat with 44° 30' cutter.

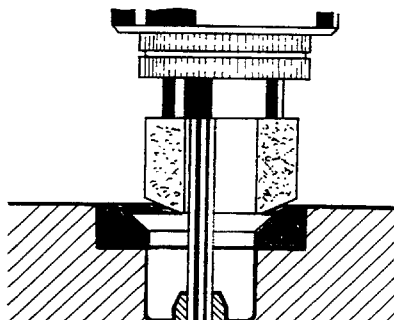

Reducing outer valve seat with 20° cutter

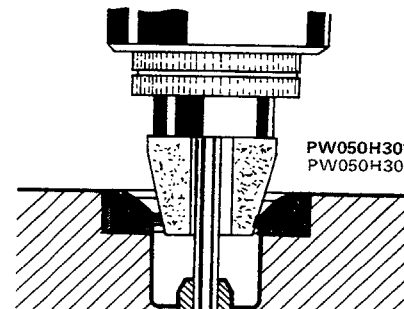

Reducing inner valve seat with 75° cutter

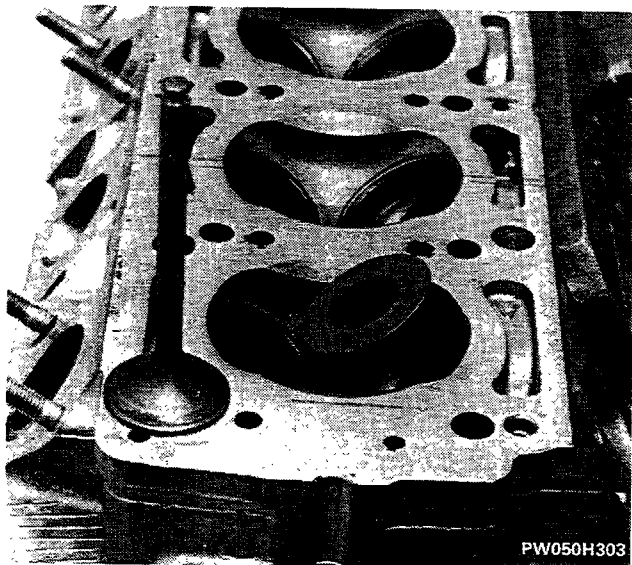

Measuring valve head line of contact on seat

NOTE *If the valve head is not centred in its location, reduce the cylinder head seat as necessary.
If centring is impossible, renew the valve seat.*

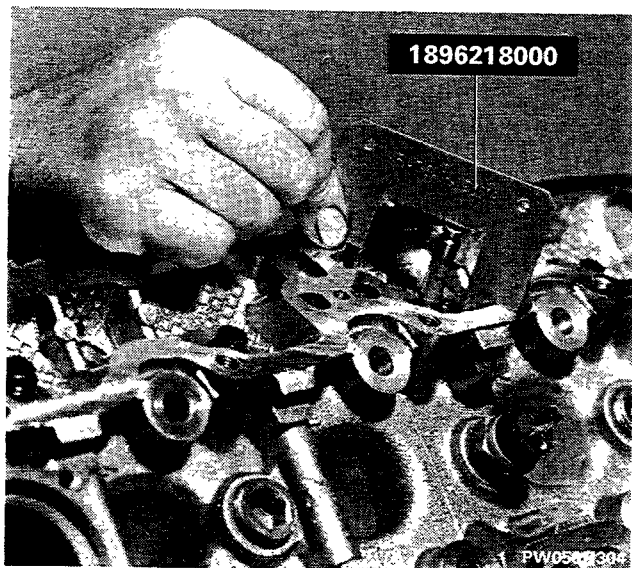

Checking valve stem height after regrinding

NOTE *If the valve stem is too high, shorten it by grinding.*

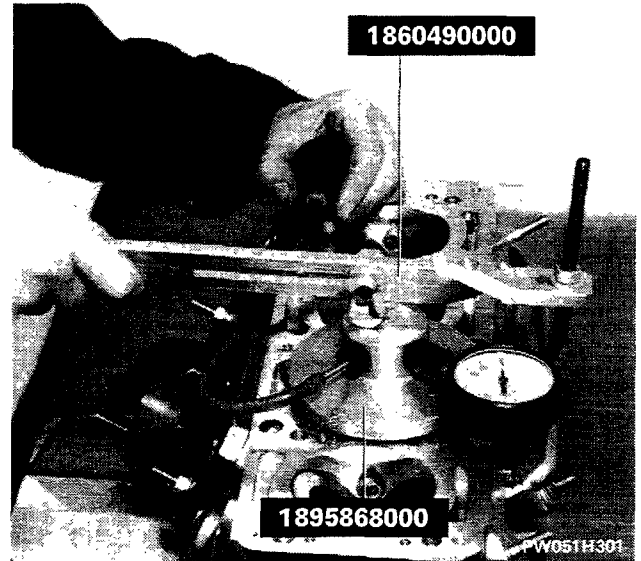

Compression testing valve seal

NOTE *The test should be performed with spark plugs fitted.*

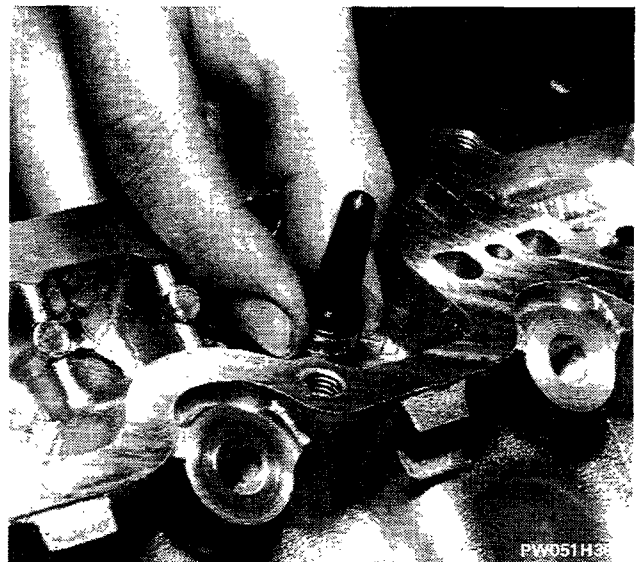

Fitting valve guide oil seals



Lubricate the parts with engine oil before final assembly.



Fitting valve guide oil seals using tool
1860313000

10.

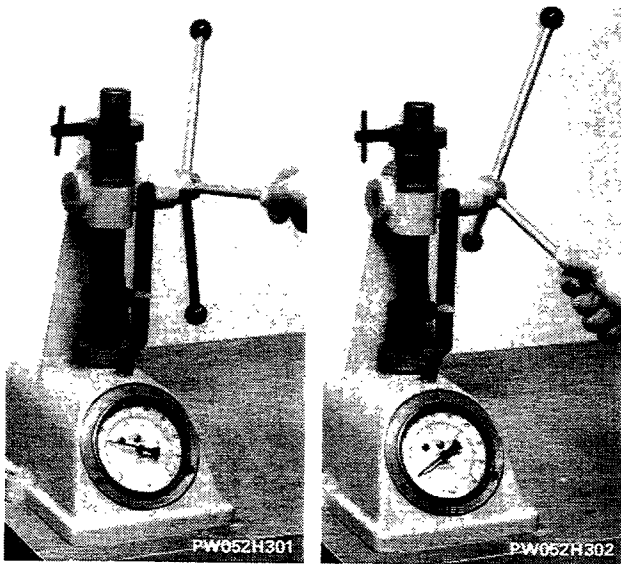

VALVE SPRINGS

Checking valve spring load

NOTE Before fitting the inner and outer valve springs, they should be checked to ensure that the minimum loads are within the tolerance limits.

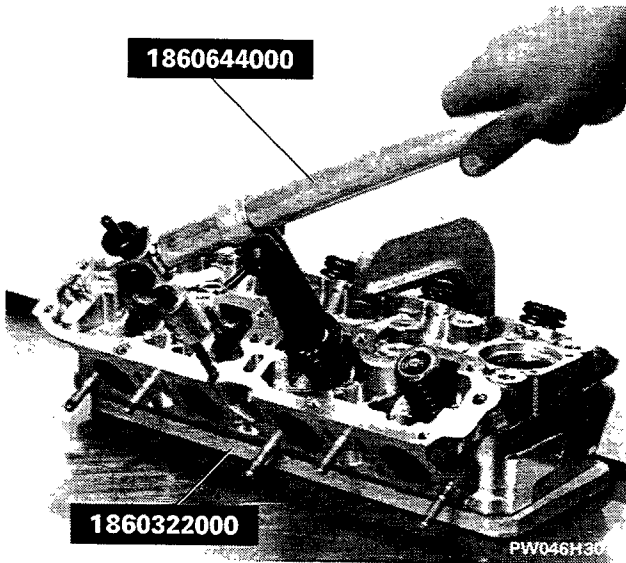

Fitting valve, caps, inner and outer springs and split taper collets

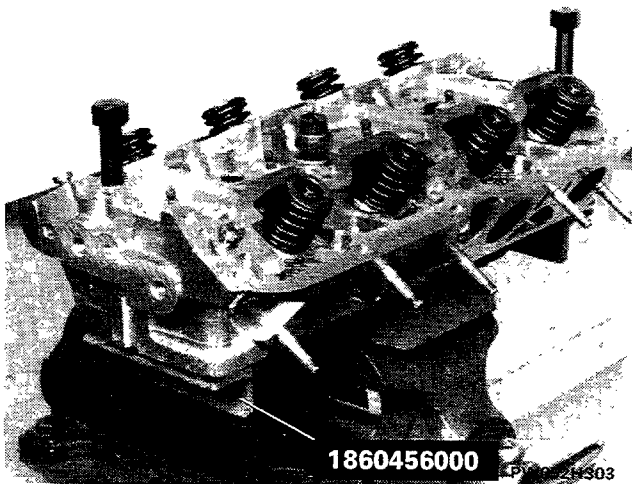

View of cylinder head with valves assembled

UPPER CYLINDER HEAD

Fitting oil seal on upper head

The oil seal is removed and fitted using an ordinary drift.

NOTE *The camshaft journal locations must not show signs of wear or scoring, otherwise the upper head will have to be renewed.*

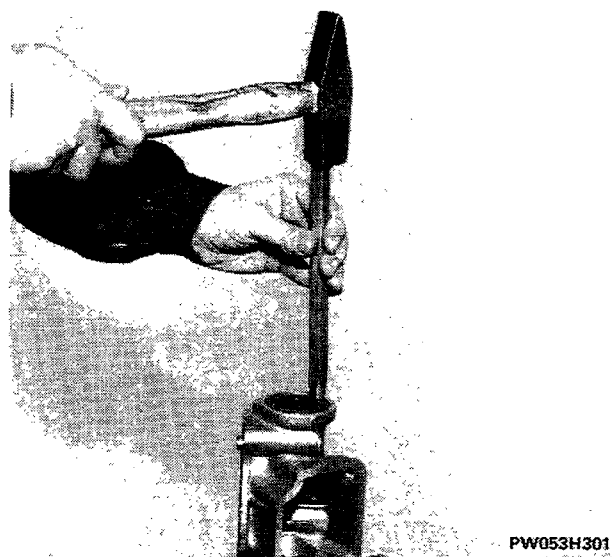

PW053H301

CAMSHAFT

ϕ_1	29,944 ÷ 29,960
ϕ_2	45,755 ÷ 45,711
ϕ_3	46,155 ÷ 46,171

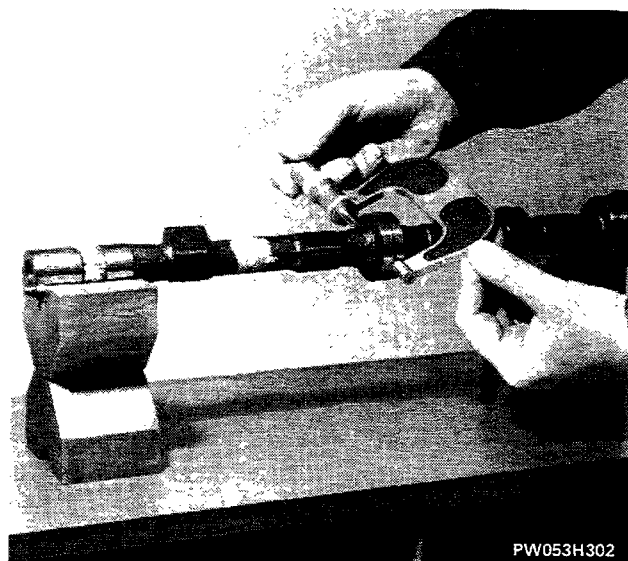

PW053H302

Measuring camshaft journals

NOTE *The cam and journal surfaces must not show signs of seizure or scoring, otherwise the camshaft will have to be renewed.*

		9,1
		8,6
		10,033
		10,033

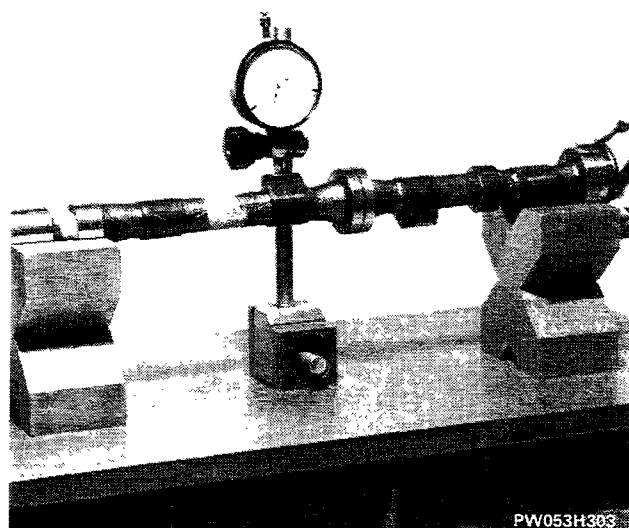

PW053H303

Measuring cam lift



The camshaft must be renewed even if only one cam is excessively worn.

10.

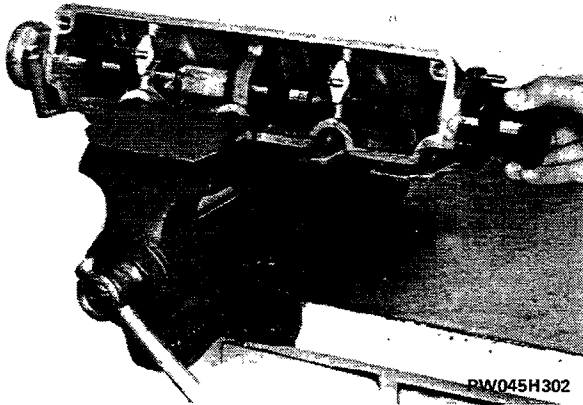

Fitting camshaft

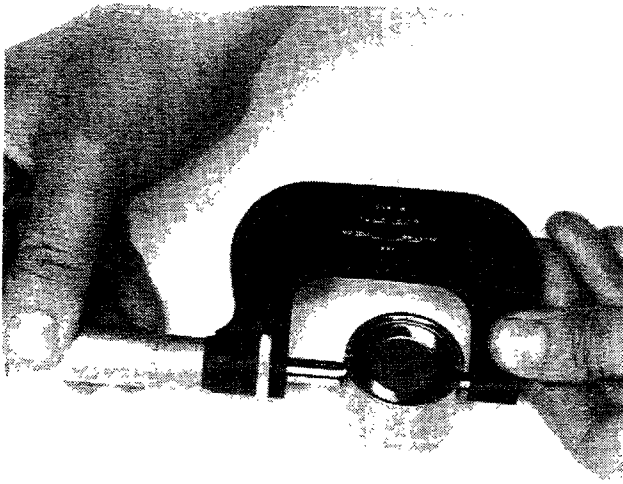

∅ 36,975 ÷ 36,995

TAPPETS



Checking tappet diameter

If excessively out of round, the tappets should be renewed.

PW054H301



∅ 37,000 ÷ 37,025



Checking seats and fitting tappets

If the tappet location is excessively worn, renew the upper cylinder head.

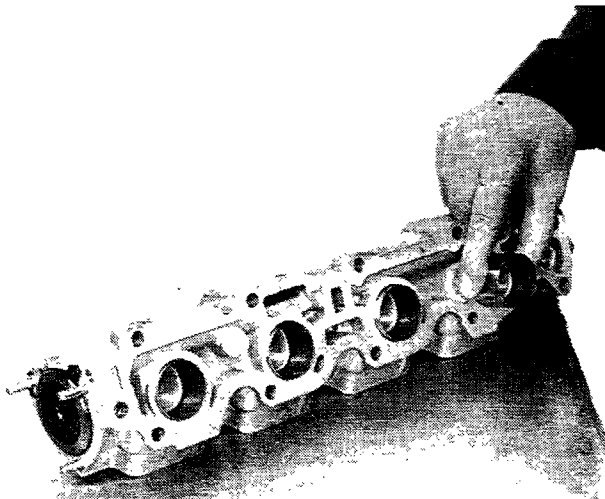

PW045H301



Lubricate the parts with engine oil before final assembly.

FITTING CYLINDER HEAD

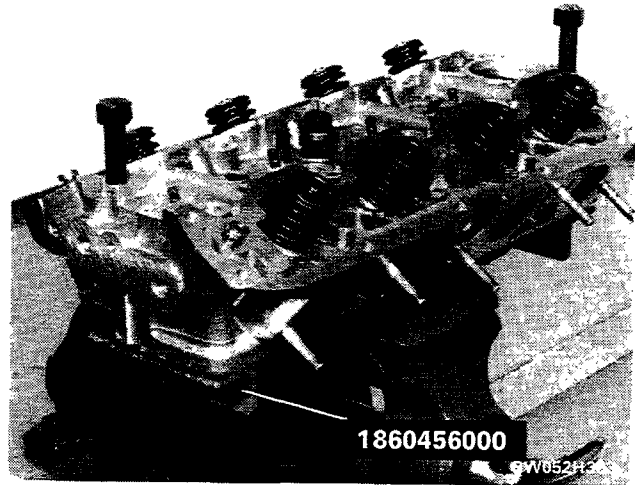

Cylinder head, without upper heads, mounted on tool 1860456000

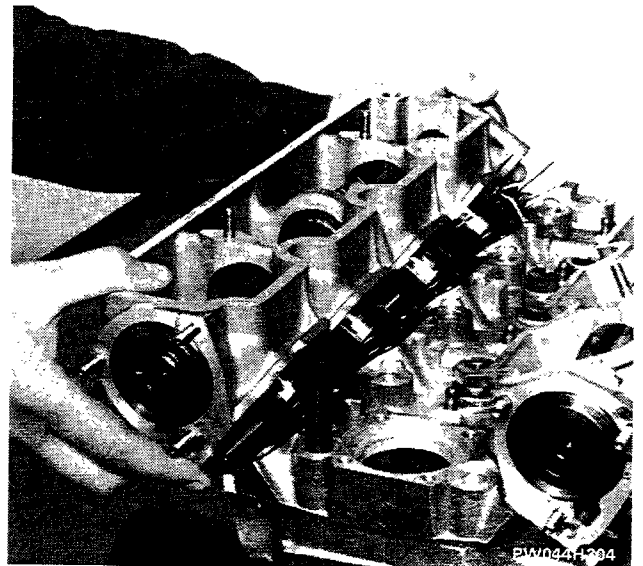

Fitting gaskets and upper cylinder heads

2,2 daNm

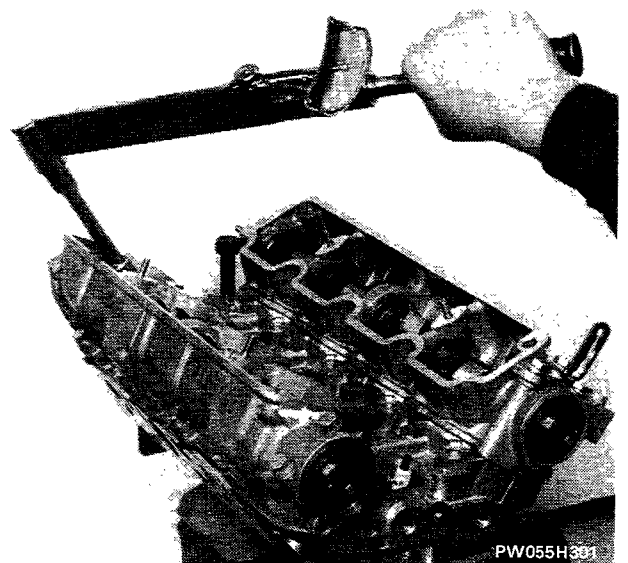

Tightening upper cylinder head bolts to correct torque

10.

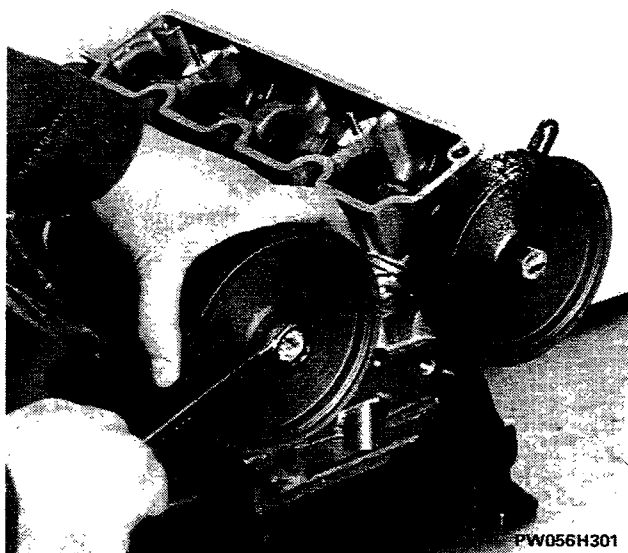

PW056H301

Provisionally fitting camshaft sprockets

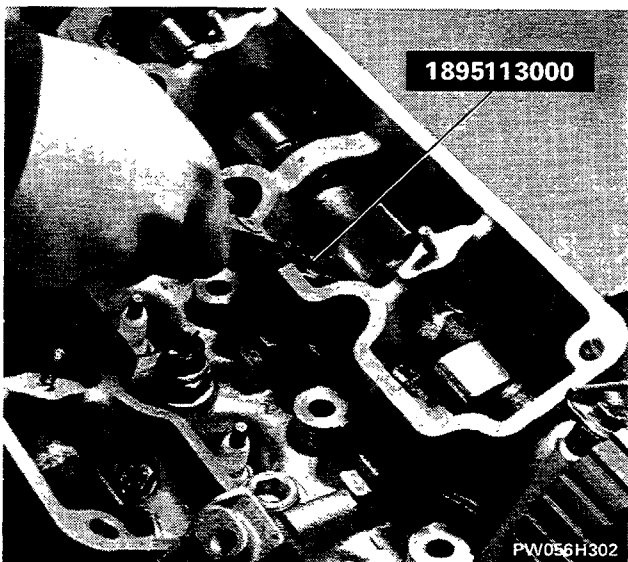

1895113000

PW056H302

ADJUSTING VALVE CLEARANCES

2000ie		$0,40 \pm 0,04$
		$0,48 \pm 0,03$
turbo		$0,35 \pm 0,04$
		$0,40 \pm 0,04$

Checking clearance between tappet and cam

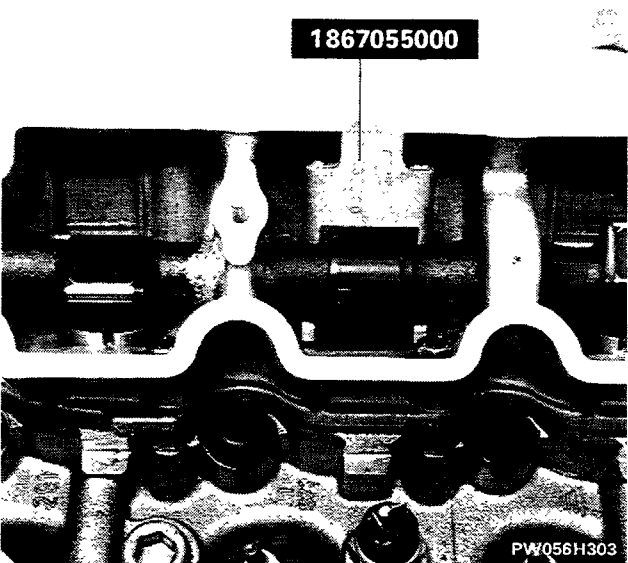

1867055000

PW056H303

Inserting tappet locking tool 1867055000

Before inserting tool 1867055000, turn the camshaft until the tappet in question is at the position where its corresponding valve is fully open.

Turning camshaft for subsequent withdrawal of tappet adjustment shim

Turn the camshaft until the tappet in question is at the position where its corresponding valve is fully closed.

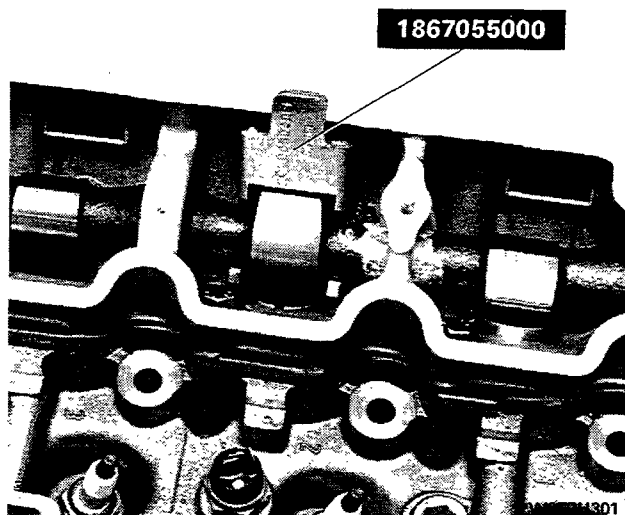

Withdrawing tappet adjustment shim using pliers 1887001000

NOTE *Fit a new shim of appropriate thickness to obtain the correct valve clearance.*

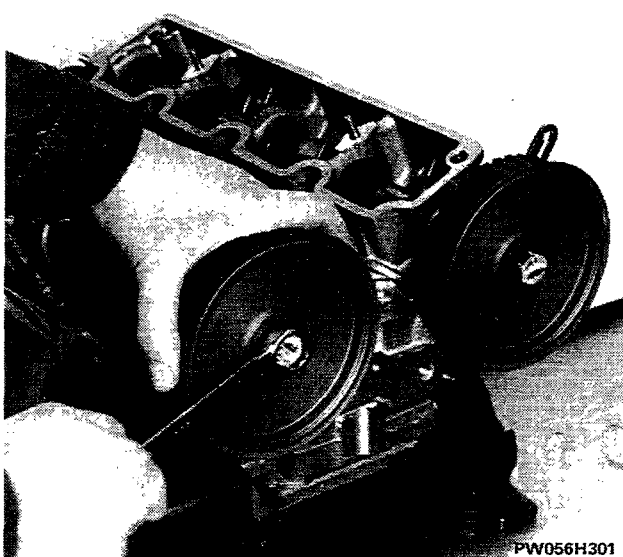
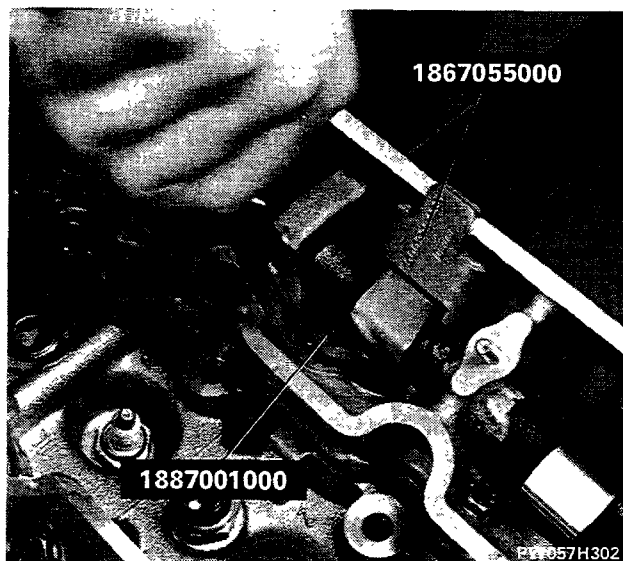

Removing camshaft sprockets

10.

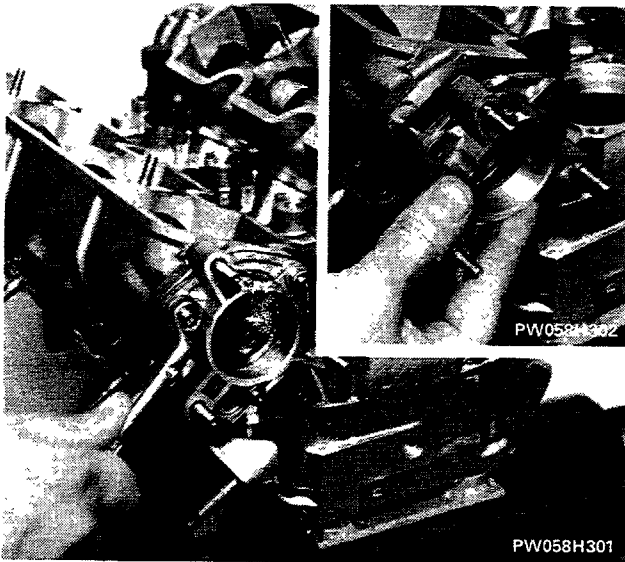

Fitting distributor mounting

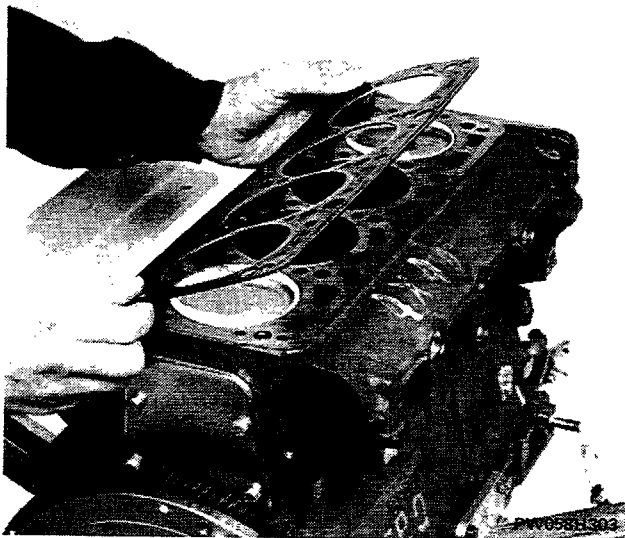

Fitting cylinder head gasket

NOTE Place the cylinder head gasket on the cylinder block with the word "ALTO" facing the fitter.

This gasket is of the ASTADUR type. Because of the special material from which it is made, it undergoes a polymerization process during engine operation, so it hardens considerably during use.

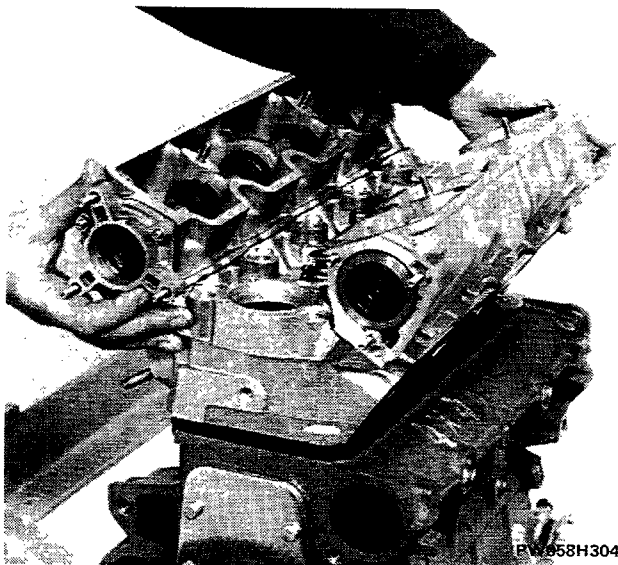

Fitting cylinder head



The following precautions are necessary to ensure polymerization of the cylinder head gasket:

- keep the gasket sealed in its nylon wrapper;
- do not unwrap until just before assembly;
- do not lubricate or dirty the gasket with oil, and make sure that the cylinder head and block surfaces are thoroughly clean.

TIGHTENING CYLINDER HEAD

Diagram showing cylinder head bolt tightening sequence

The correct cylinder head bolt tightening procedure is as follows, bearing in mind that for each stage, the tightening sequence is as illustrated:

- lubricate the bolts and washers and allow to drain for at least 30 minutes;

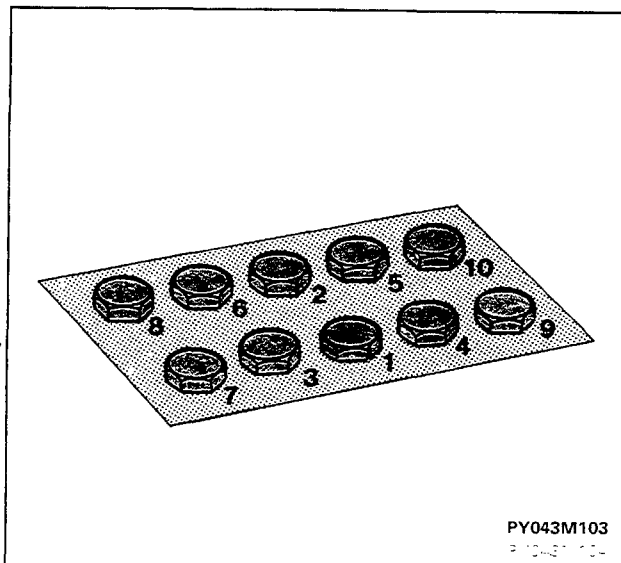

PY043M103
FIG. 10-37 103

Pretightening cylinder head bolts in two stages with a torque wrench (2 + 2 daNm)

- initially tighten the bolts to 2 daNm;
- tighten to 4 daNm using a torque wrench.

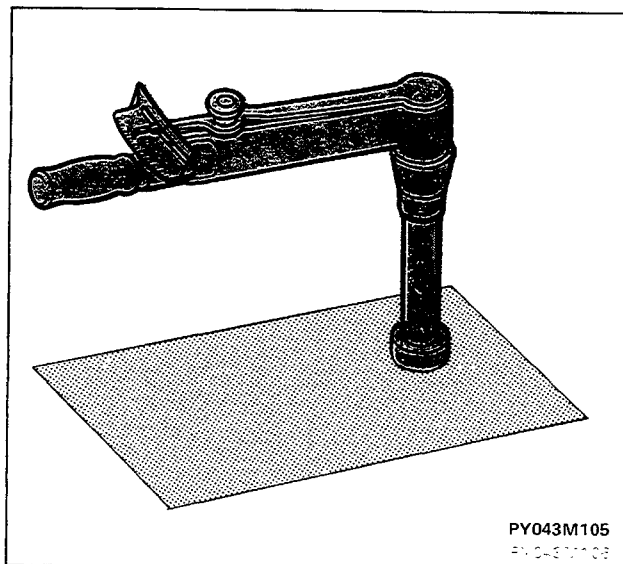

PY043M105
FIG. 10-37 105

Angle tightening cylinder head bolts in two stages (90° + 90°)

- using an ordinary tommy bar, tighten the bolts again by 180° in two separate stages (90° + 90°), following the correct order for each stage.

NOTE Since an *ASTADUR* type gasket is used, the cylinder head bolts need not be retightened after 1000-1500 km.

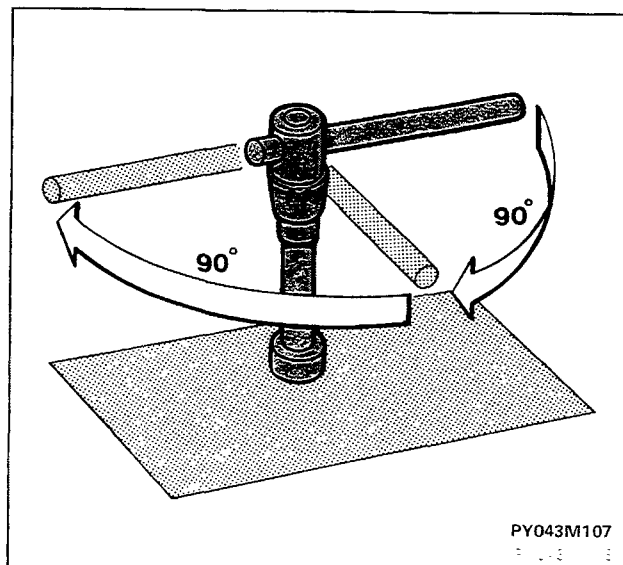

PY043M107
FIG. 10-37 107

10.

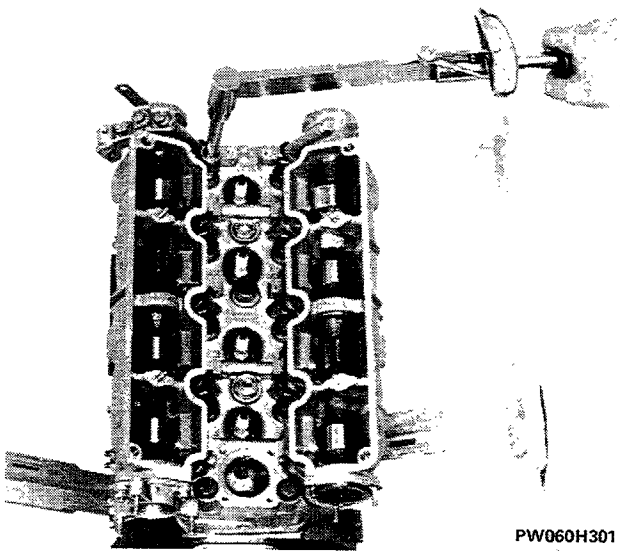

PW060H301



2 + 2 daNm

Pretightening cylinder head bolts by torque wrench in two stages (2 + 2 daNm)

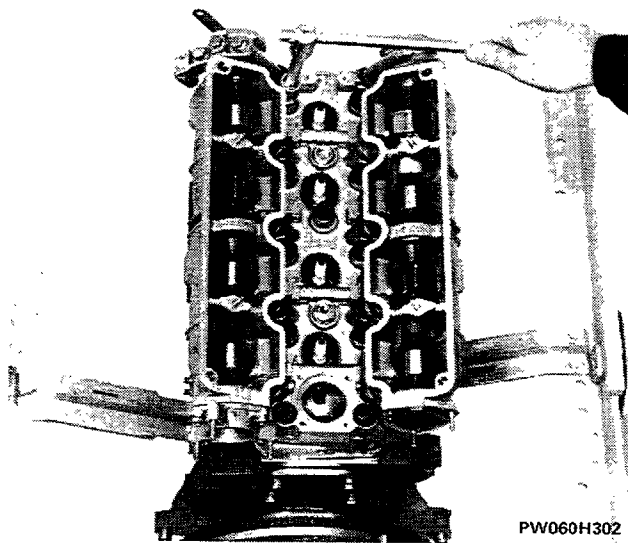

PW060H302



90° + 90°

Angle tightening cylinder head bolts in two stages (90° + 90°)

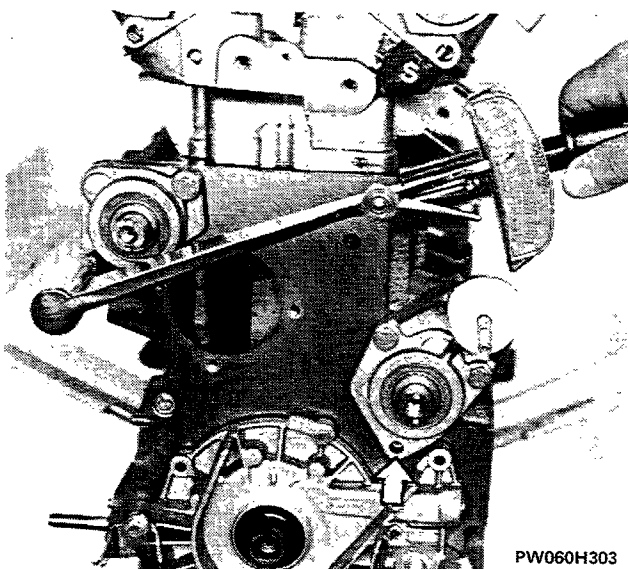

PW060H303



REFITTING VARIOUS COMPONENTS



2,3 daNm

Fitting counter shaft covers and tightening bolts to correct torque

NOTE *The arrows shows the location of the guard bolt, which is fitted subsequently.*

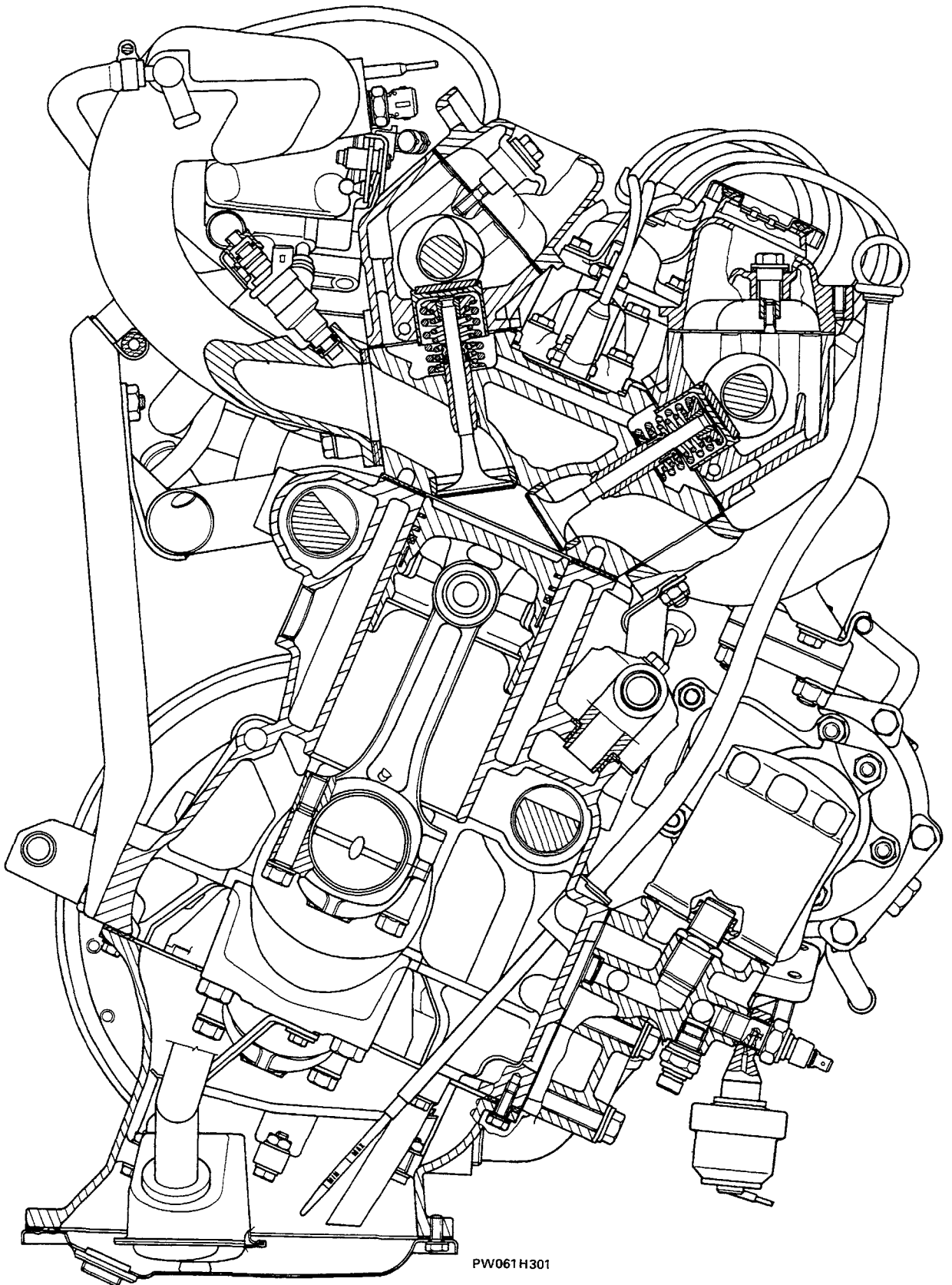

PW061H301

CROSS SECTION 2000ie turbo

10.

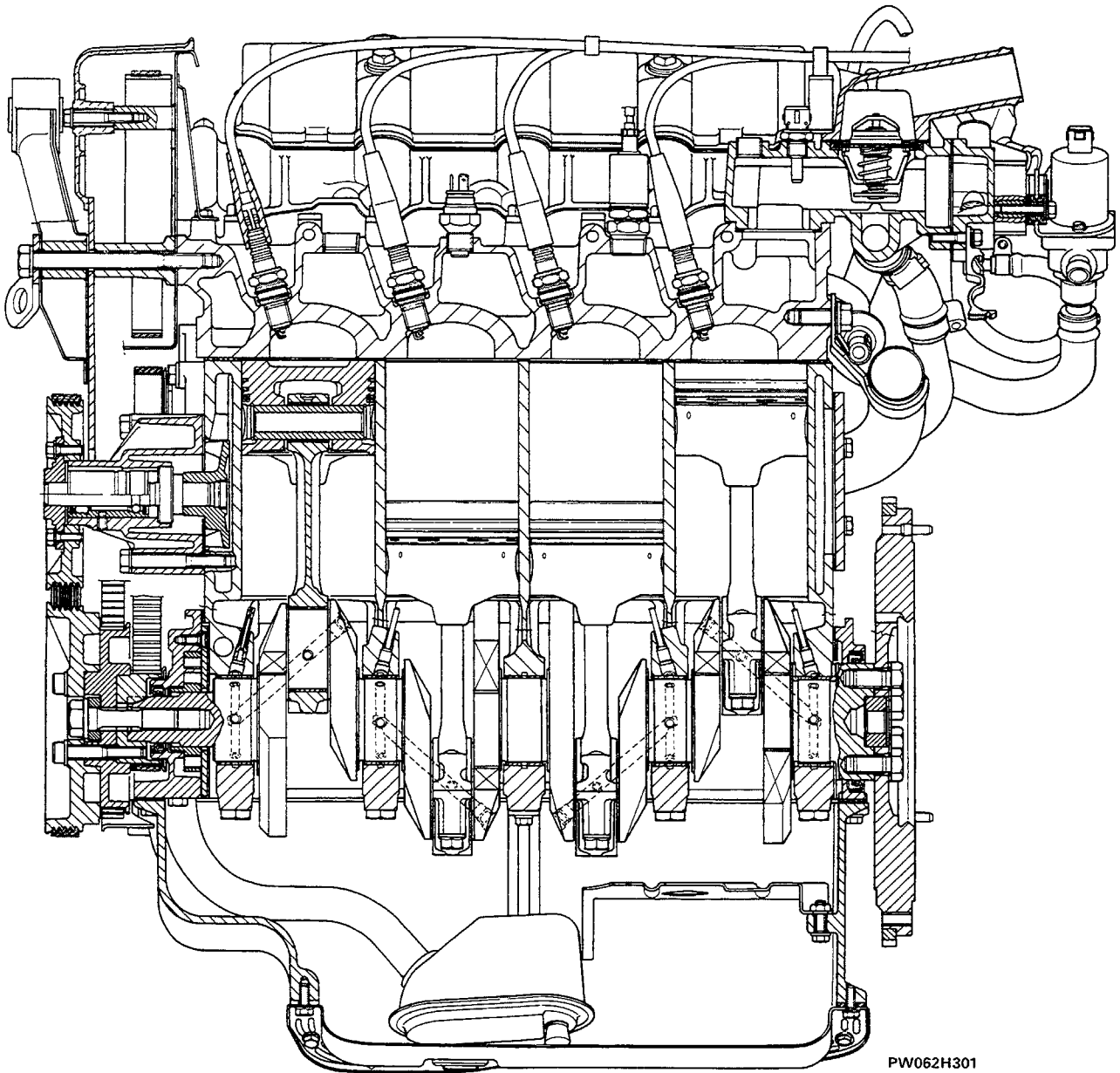

PW062H301

LONGITUDINAL SECTION  turbo

Fitting right counter shaft bottom guard

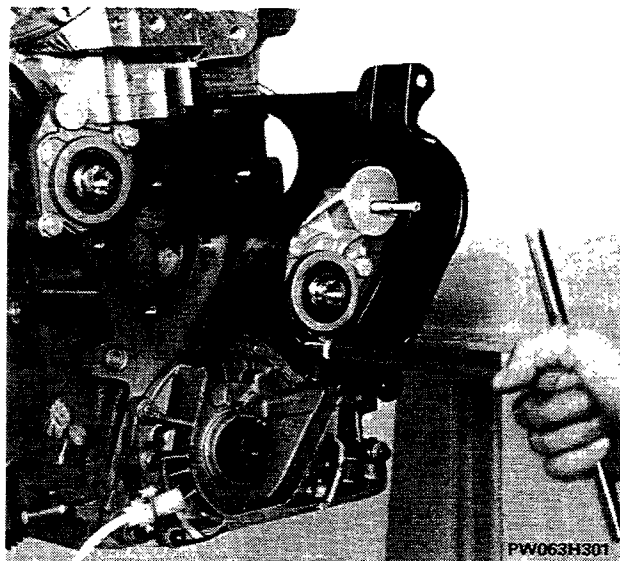

PW063H301

Fitting counter shaft sprockets



When fitting the sprockets on their respective counter shafts, make sure that with the balancing weights facing downwards, the notches on the sprockets are positioned as shown by the arrows in the photo.

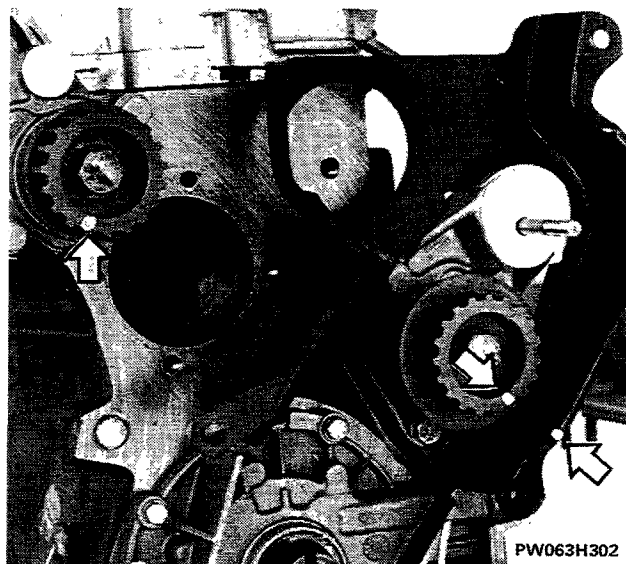

PW063H302

Provisionally tighten the sprocket bolts

11,8 daNm



Tightening left counter shaft sprocket bolt to correct torque

NOTE *As a stop for tool 1860473000, use a bolt, shown by the arrow, screwed into the cylinder head.*

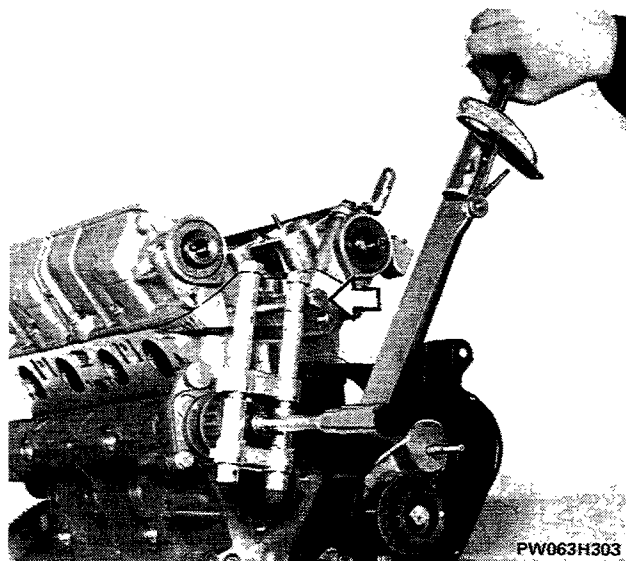

PW063H303

10.

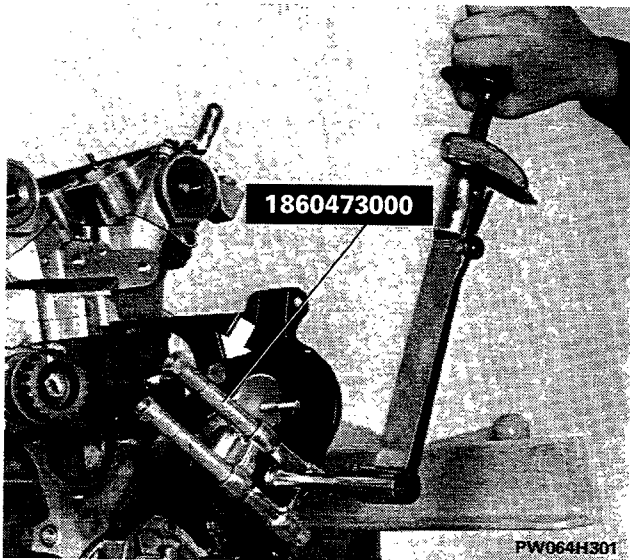

11,8 daNm

Tightening right counter shaft sprocket bolt to correct torque

NOTE *As a stop for tool 1860473000, use a bolt, shown by the arrow, screwed into the cylinder block.*

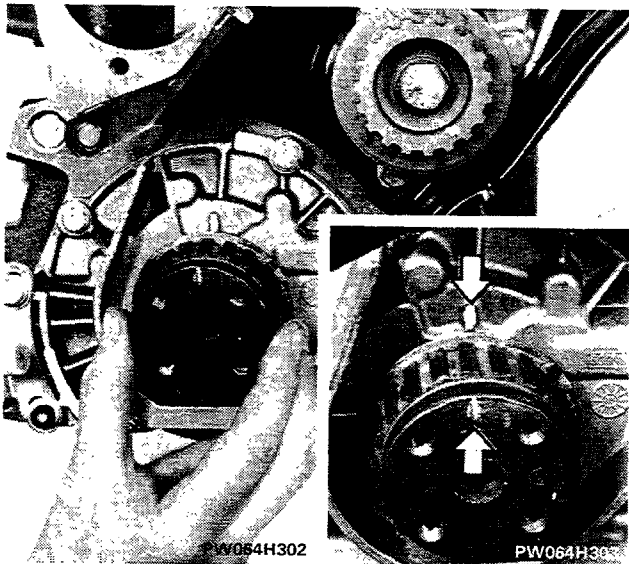

REFITTING TIMING GEAR COMPONENTS

Fitting camshaft sprocket

Turn the crankshaft until the reference mark on the sprocket is lined up with the projection on the front cover, as shown by the arrows in the detail photo.

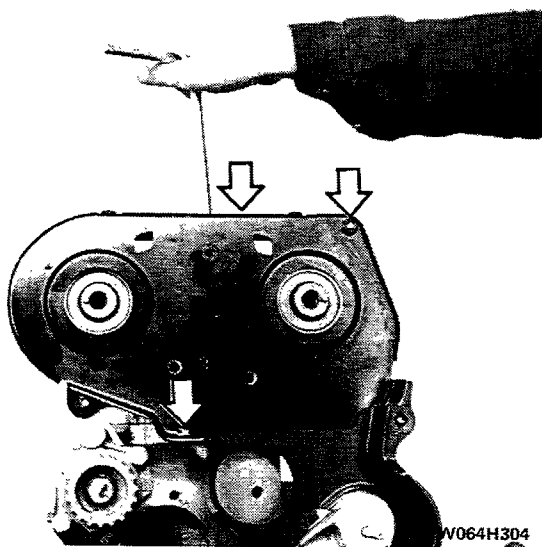

Fitting camshaft sprocket top cover.

NOTE *The arrows show the cover's bolts.*

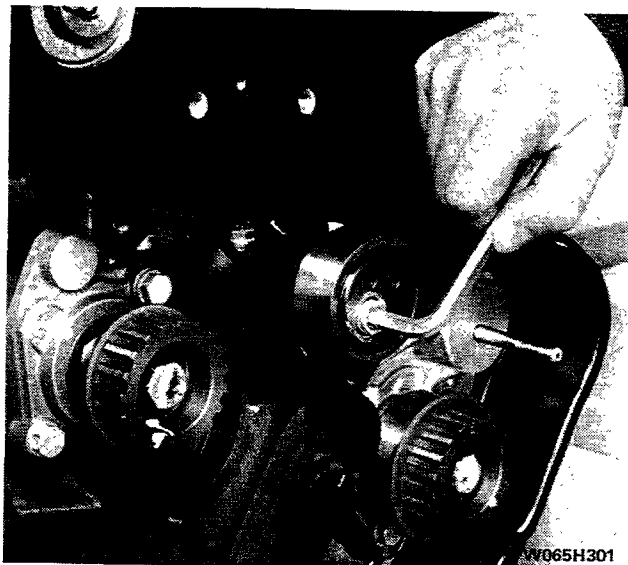

Fitting timing belt tensioner

NOTE Provisionally tighten the bolt.

PW065H301



11,8 daNm



1860473000

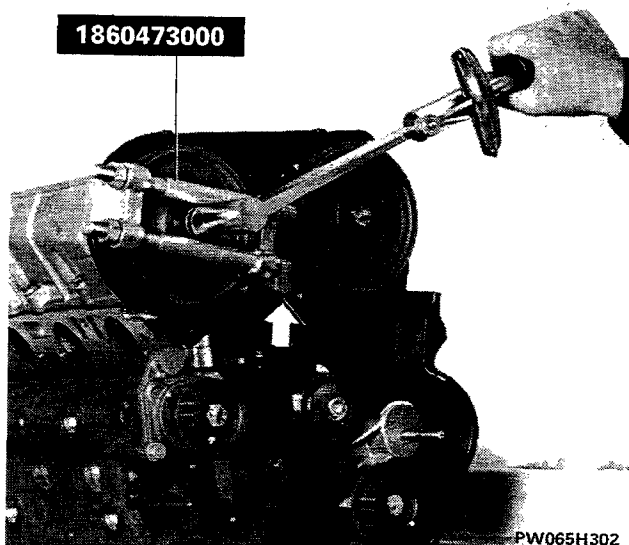

PW065H302

Fitting camshaft sprockets and tightening bolts to correct torque

NOTE As a stop for tool 1860473000, use a bolt, shown by the arrow, screwed into the cylinder head.

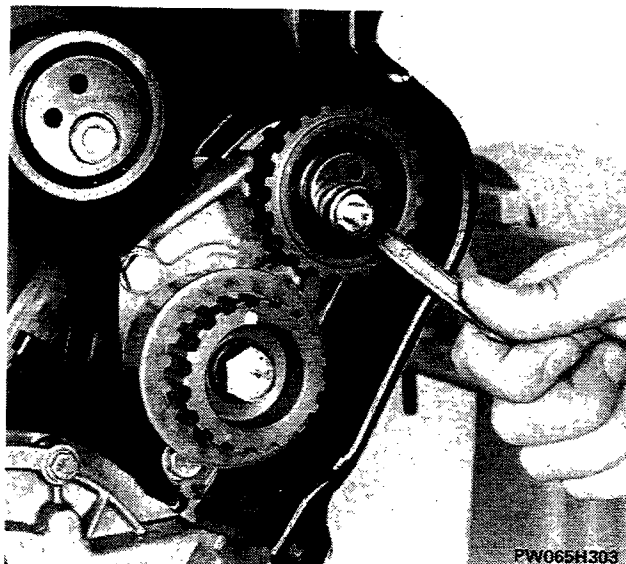

PW065H303

Fitting counter shaft belt tensioner

NOTE Provisionally tighten the nut.

10.

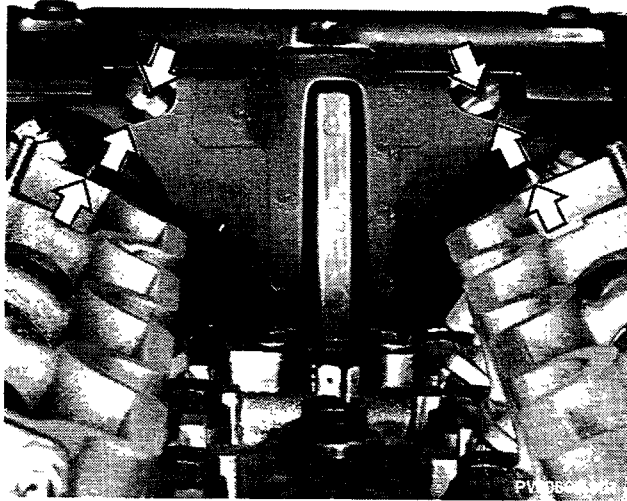

ADJUSTING VALVE TIMING

Position the camshaft sprockets so that the notches on the rear of the sprockets line up with the slots on the rear cover and the projections on the upper heads.

Turn the crankshaft until the reference mark on the crankshaft sprocket is lined up with the notch on the front cover.
Then fit the timing belt.

NOTE *Visually check the condition of the timing belt every 40,000 km, and replace it if it is:*

- soaked in oil or coolant;
- cracked or with broken teeth;
- frayed or with a worn tooth profile.

It must be fitted new if removed during repair work.

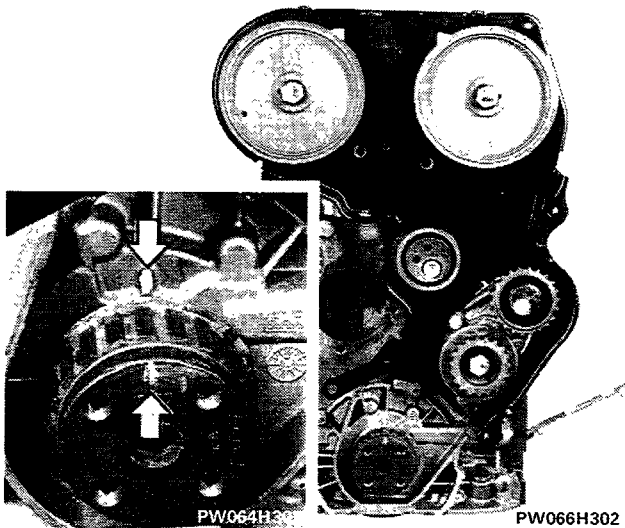

Fitting timing belt

When fitting the timing belt, make sure that the teeth are properly engaged in all the sprockets.

NOTE *To avoid damaging the belt fibres during assembly, take the utmost care not to bend the timing belt into tight angles.*

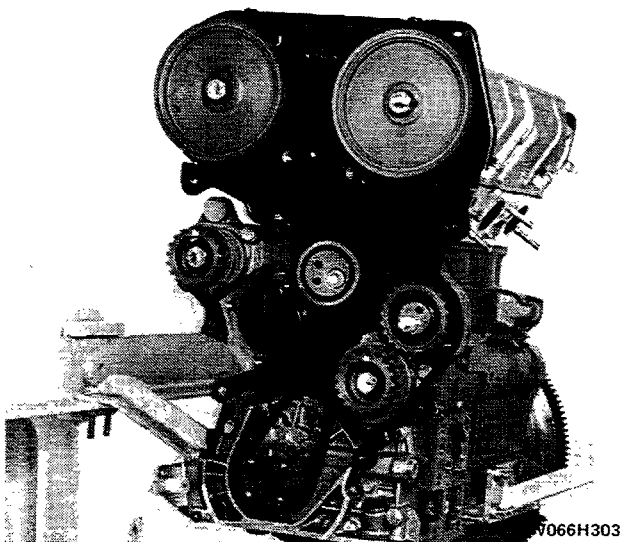

ADJUSTING TIMING BELT TENSION

Fit part 1860745200 to tool 1860745100, then position the weight at 140 mm on the graduated bar and secure it.

Mount the tool thus prepared on the belt tensioner as illustrated in the photo, then adjust the joint to set the bar on the horizontal.

Allow the belt to bed in by turning the crankshaft two revolutions in its direction of rotation and then tighten the belt tensioner bolt.

NOTE *During the final stage, the graduated bar may move from its horizontal position; if this occurs, readjust the joint to set the bar in its original position and repeat the procedure.*

Mounting tool 1860745100 on the belt tensioner

Detail of fitting of tool 1860745200 on belt tensioner

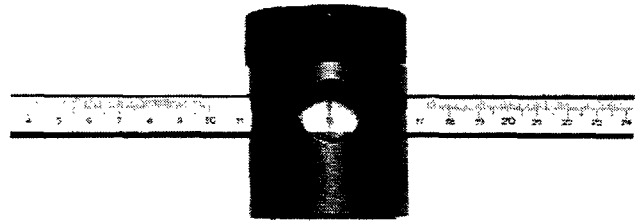

PW067H301

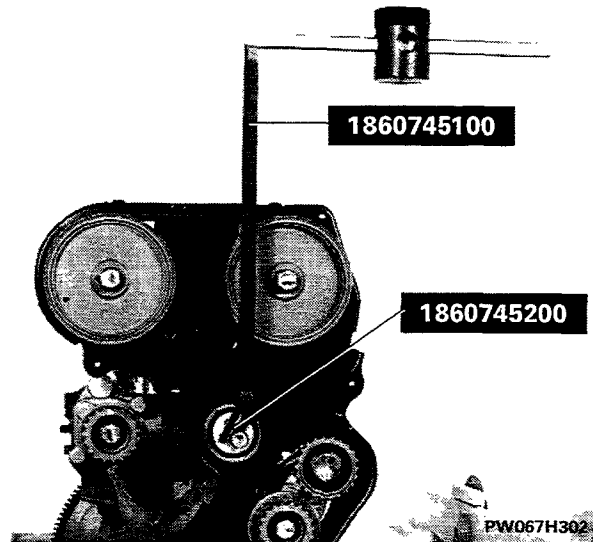

PW067H302

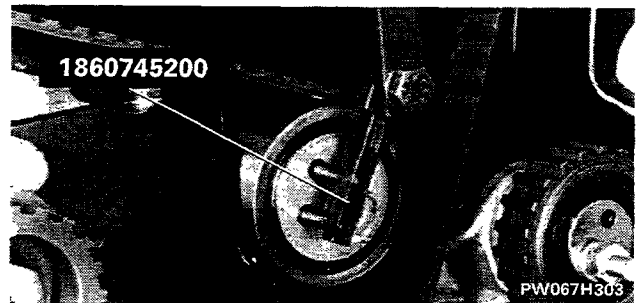

PW067H303

4,4 daNm



1860745100

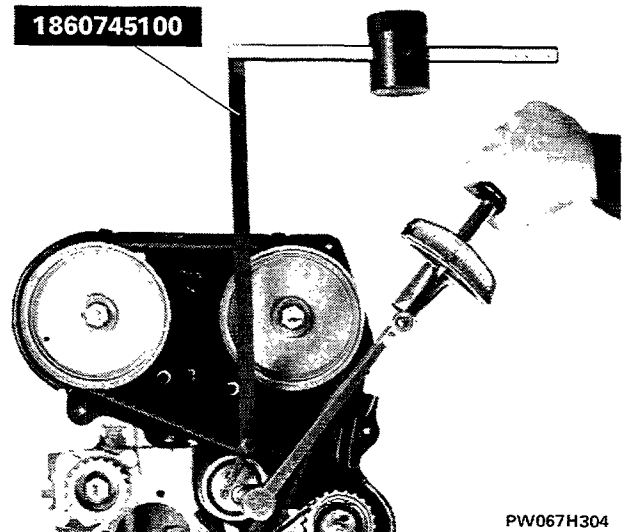

PW067H304

Tightening belt tensioner bolt to torque

10.

REFITTING VARIOUS COMPONENTS



2,5 daNm

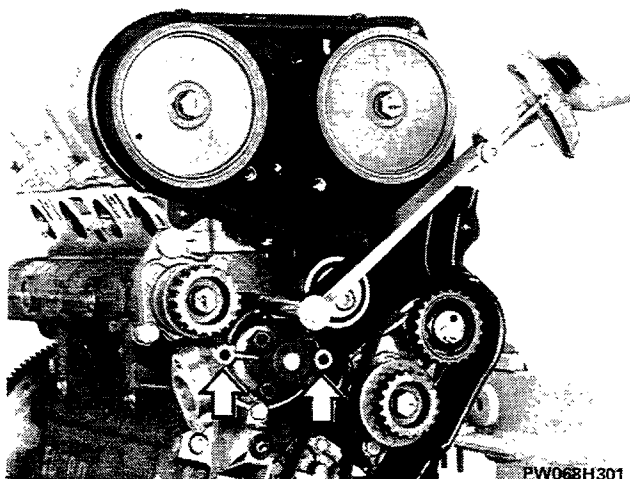

Fitting water pump and tightening its bolts to specified torque

NOTE *The arrows show the locations of the bolts securing the idler gear housing mounting, which are fitted subsequently.*

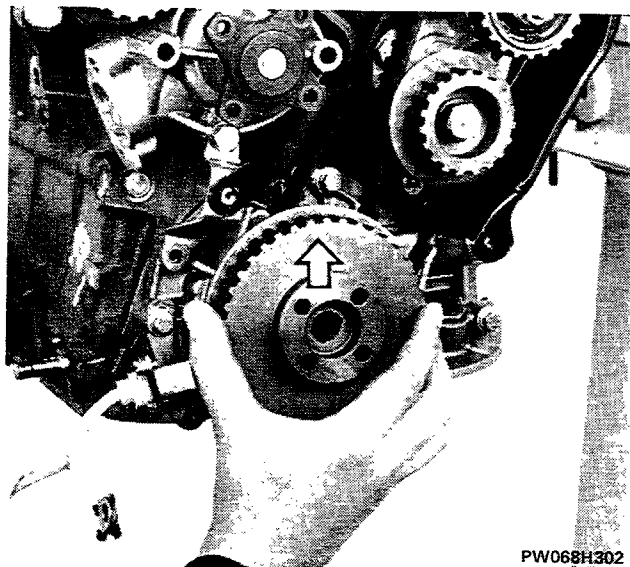

Fitting counter shaft sprocket

NOTE *Check that the valve timing is correct, and position the counter shaft sprocket so that the reference mark is facing upwards.*



19 daNm

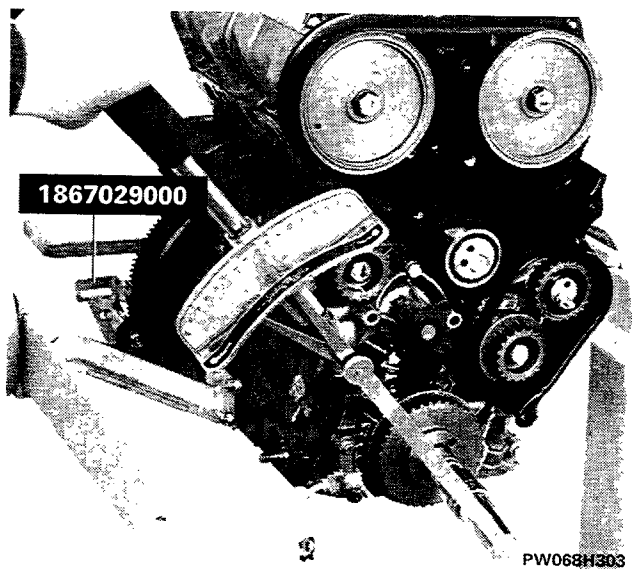

Tightening counter shaft sprocket bolt (left-hand thread) to correct torque



Use flywheel locking tool 1867029000.

Positioning counter shafts



The reference notch on the left sprocket must line up with the projection on the water pump.

The reference notch on the right sprocket must line up with the notch on the counter shaft protective cover.

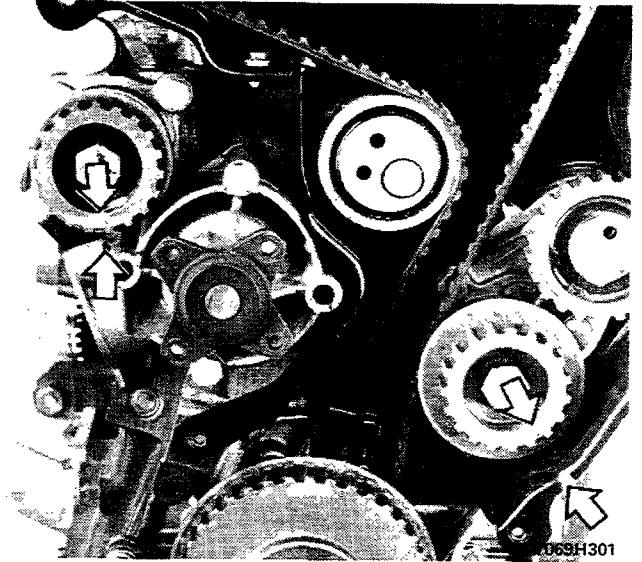

PW069H301

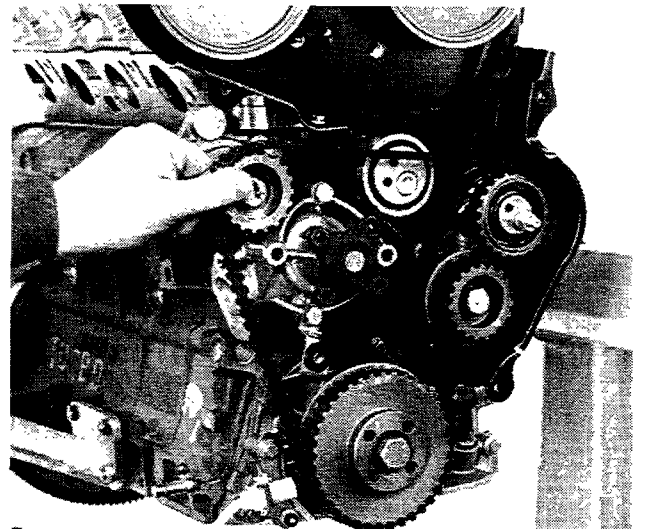

PW069H302

Fitting counter shaft double-sided toothed belt

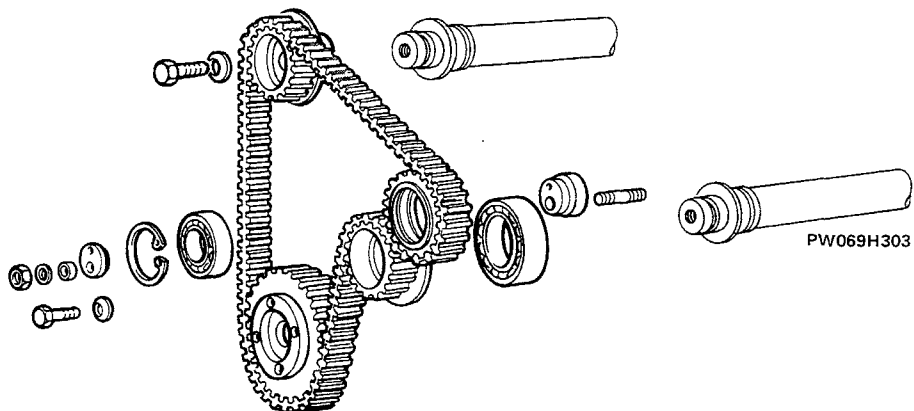

PW069H303

Components of the counter shaft drive system

10.

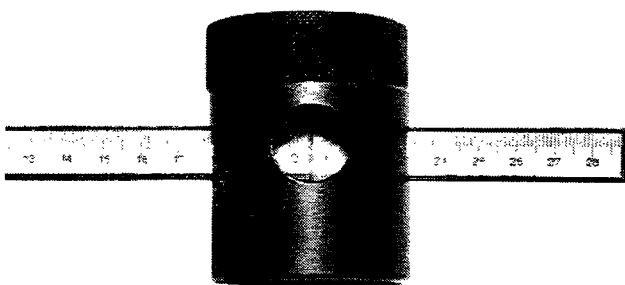

PW070H301



ADJUSTING TENSION OF COUNTER SHAFT DOUBLE-SIDED TOOTHED BELT

Fit part 1860745400 to tool 1860745100, then position the weight at 205 mm on the graduated scale and secure it.

Mount the tool thus prepared on the belt tensioner as illustrated in the photo, and adjust the joint to set the bar on the horizontal.

Allow the belt to bed in by turning the crankshaft two revolutions in its direction of rotation and tighten the belt tensioner bolt.

NOTE *During the final stage, the graduated bar may move from its horizontal position; if this occurs, readjust the joint to set the bar in its original horizontal position and repeat the procedure.*

Fitting tool 1860745100 to belt tensioner

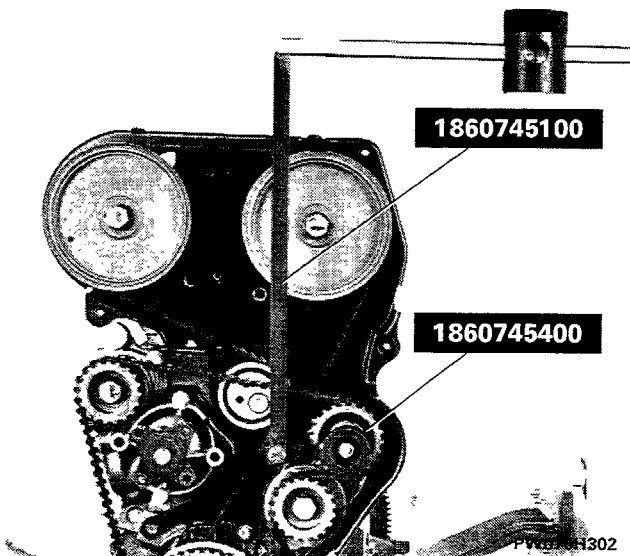

1860745100

1860745400

PW070H302

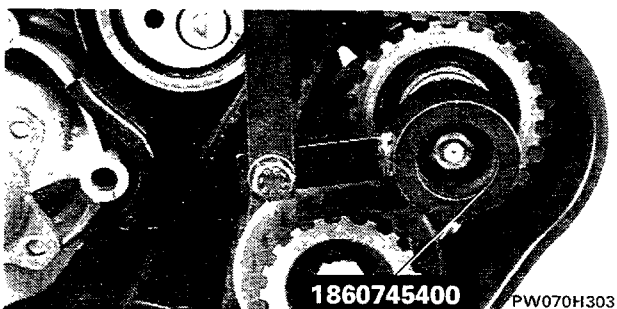

1860745400

PW070H303

Detail of fitting of tool 1860745400 to belt tensioner

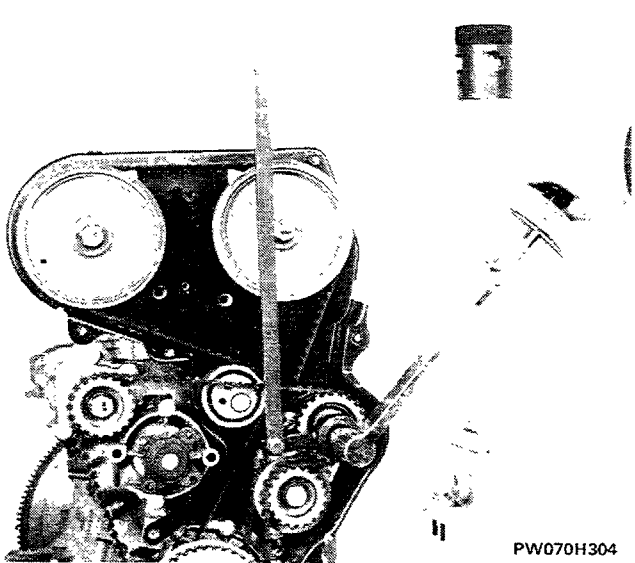

PW070H304



2.3 daNm

Tightening belt tensioner bolt to torque

COMPLETION OF ASSEMBLY

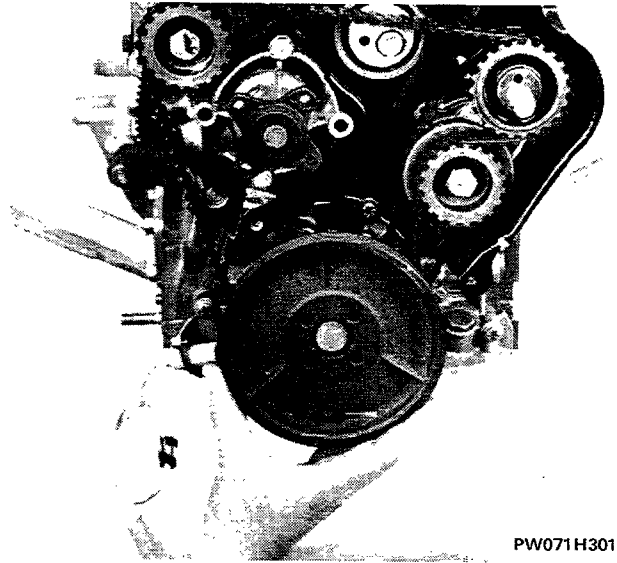

PW071H301

Fitting water pump pulley

2,5 daNm

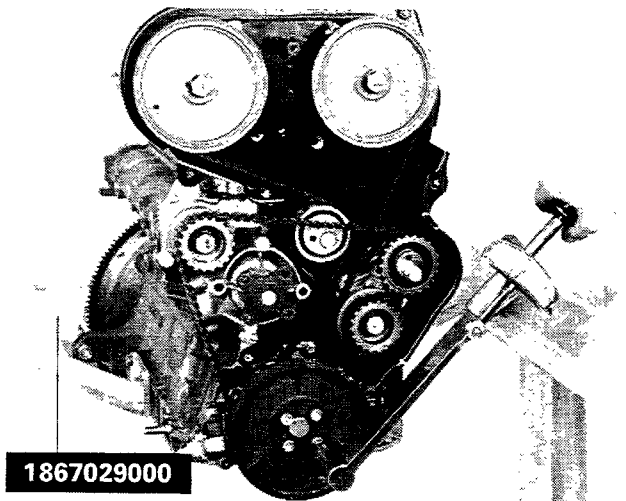

1867029000

PW071H302

Tightening water pump pulley bolts to correct torque



Use the flywheel locking tool 1867029000.

After this operation, remove the flywheel locking tool 1867029000.



M8: 2,5 daNm
M10: 4,3 daNm



Fitting water pump pipe and tightening bolts to correct torque

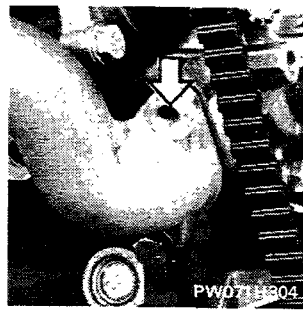

PW071H304

NOTE The arrow in the detail photo indicates the location of the bolt to be fitted subsequently, which secures the pipe, belt side cover and wiring bracket for the rpm and TDC sensor.

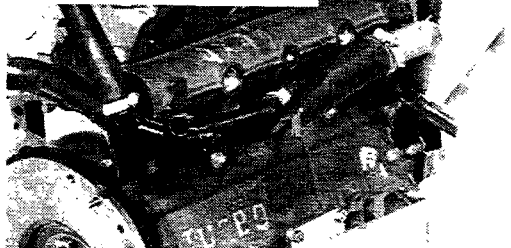

PW071H303

10.

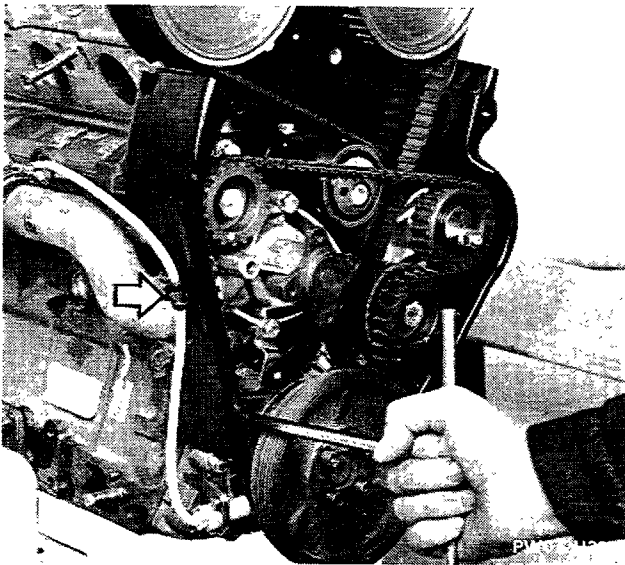

2,5 daNm

Fitting timing gear side cover

NOTE *The arrow shows the bolt to be tightened to a torque of 2.5 daNm.*

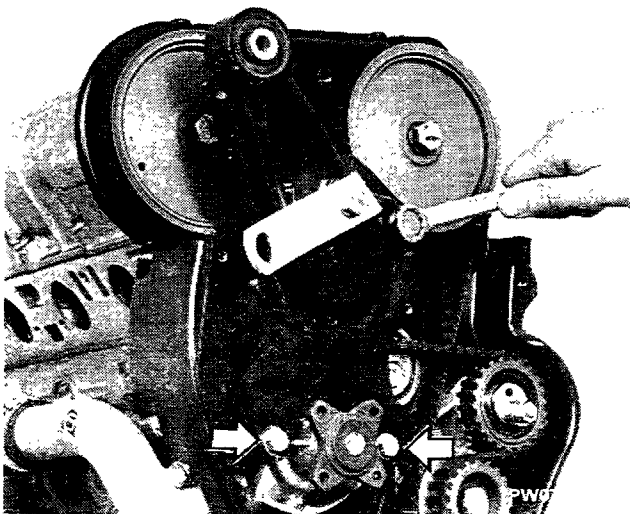

2,5 daNm

Fitting idler gear housing mounting



Tighten to 2.5 daNm the bolts shown by the arrows, which secure both the mounting and the water pump to the cylinder block.

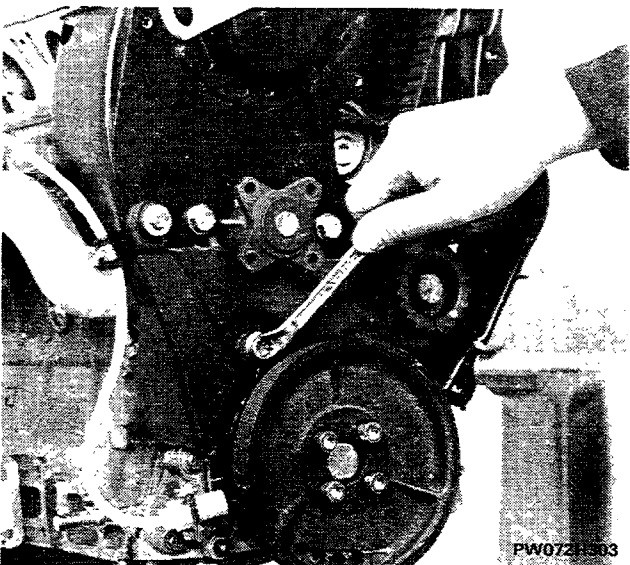

Fitting water pump bottom cover

Fitting water pump pulley

NOTE *Tighten the pulley bolts using the necessary counteracting force.*

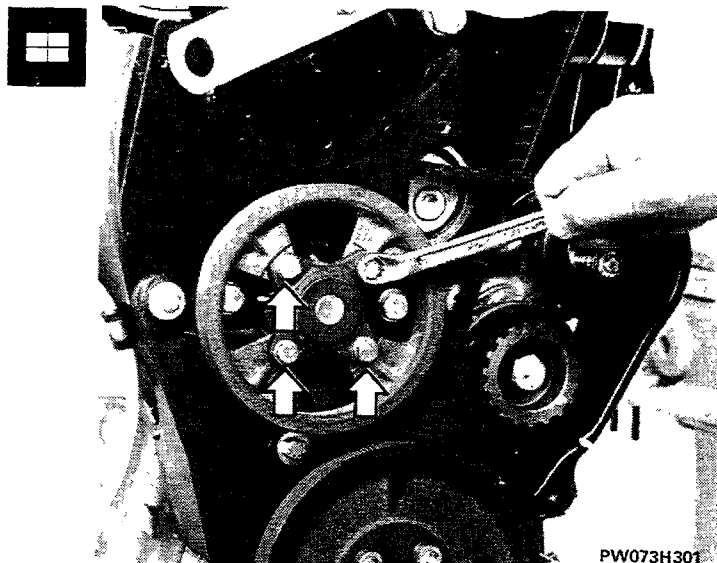

**M8: 2,5 daNm
M10: 4,3 daNm**

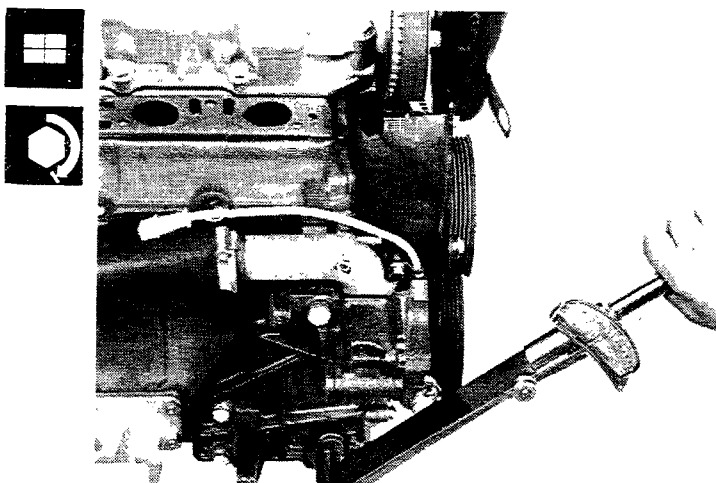

Fitting alternator bracket and tightening its nut and bolts to correct torque

2,5 daNm

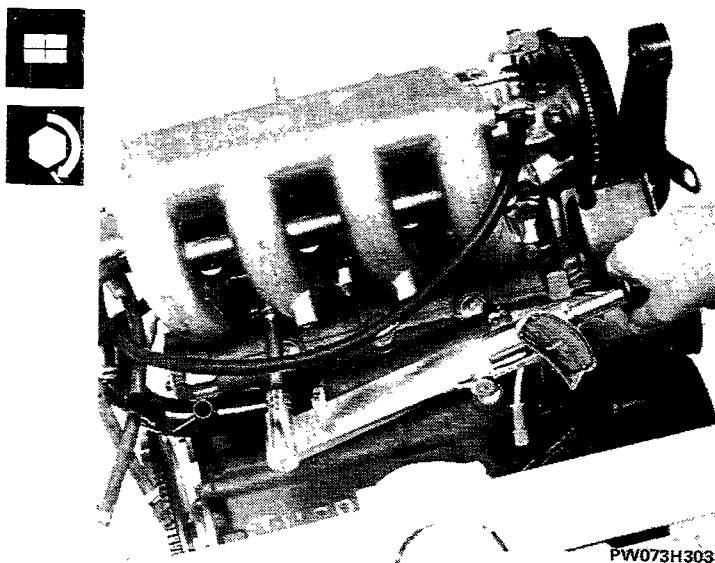

Fitting inlet manifold and tightening its nuts and bolts to correct torque

10.

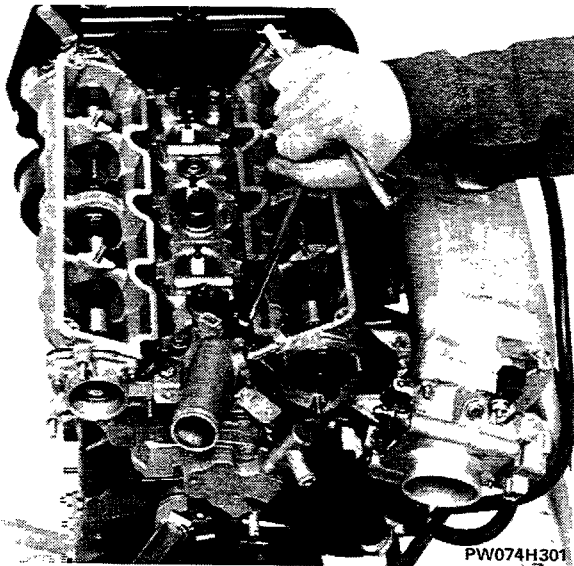

Fitting thermostat assembly to cylinder head

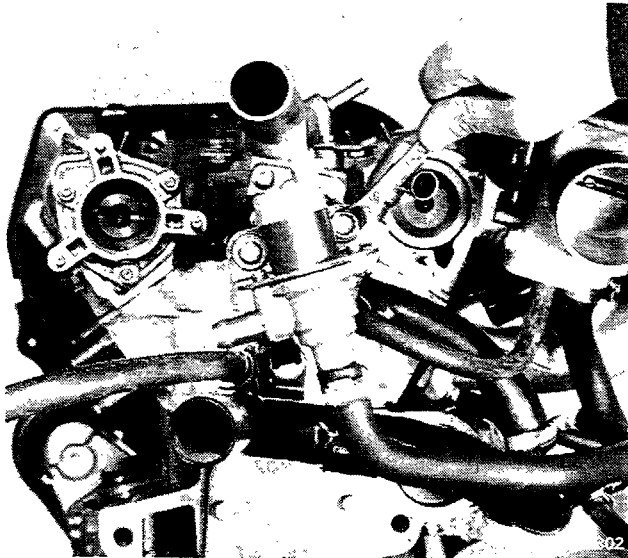

Fitting auxiliary air solenoid for automatic idle adjustment

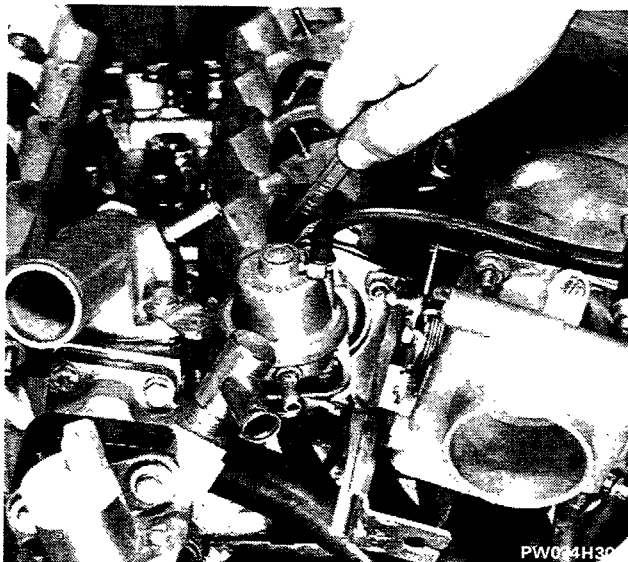

Fitting fuel pressure regulator

Fitting rocker covers

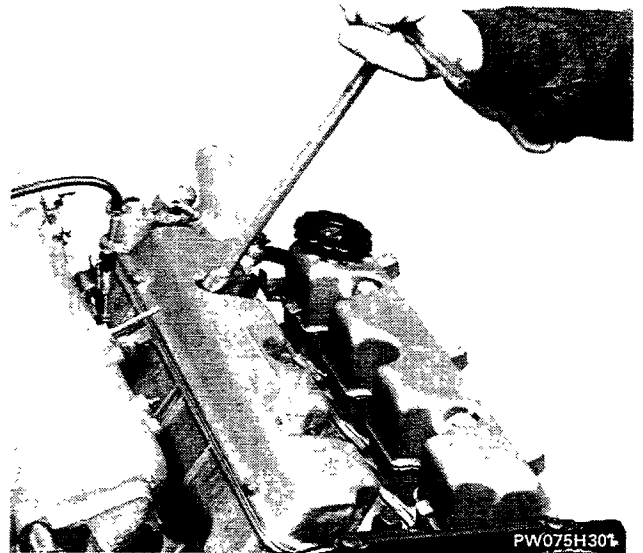

Fitting distributor



Before fitting the distributor in its mounting, line up the rotor arm halfway point with the reference notch on the dust cover under the distributor cap.

The engine's piston n° 1 should be at TDC on the power stroke.

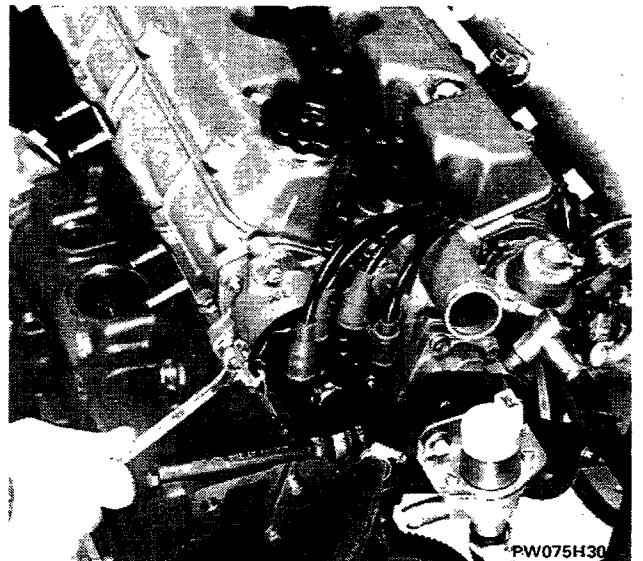

2,3 daNm



Fitting crankcase breather and tightening bolt to correct torque

NOTE The pipe should be fitted after the exhaust manifold.

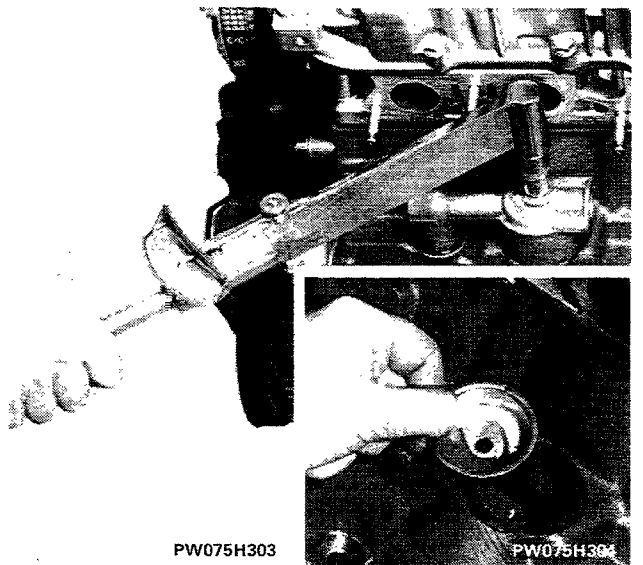

10.

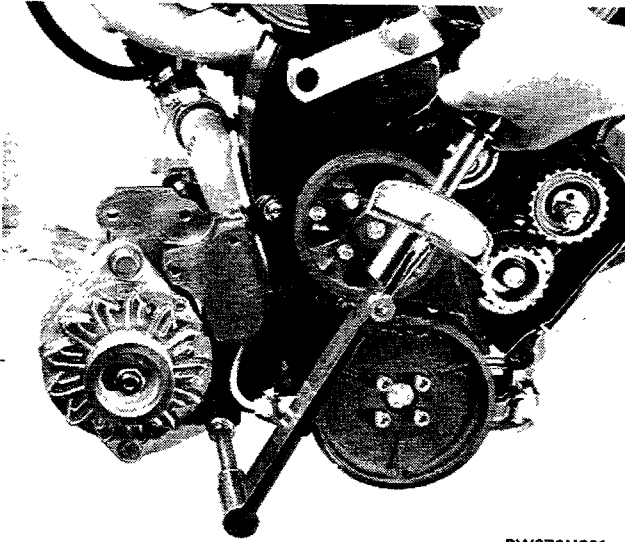

PW076H301



M10: 4,3 daNm
M12: 6,9 daNm

Fitting alternator and tightening its bolts to correct torque

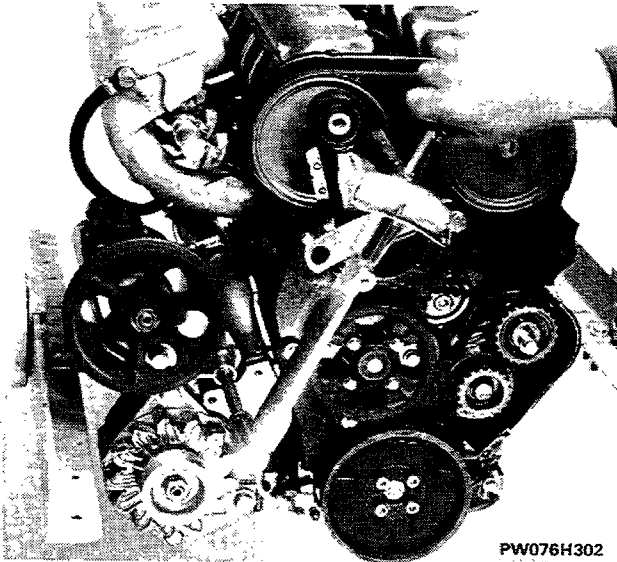

PW076H302



M8: 2 daNm
M10: 4,3 daNm

Fitting power steering pump and tightening its bolts to correct torque

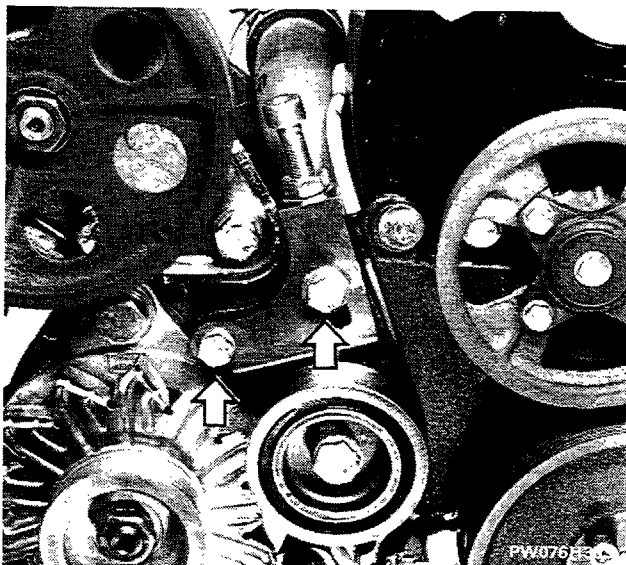

Fitting belt tensioner for alternator, water pump and power steering pump poly-V belt

NOTE Provisionally tighten the two bolts shown by the arrows.

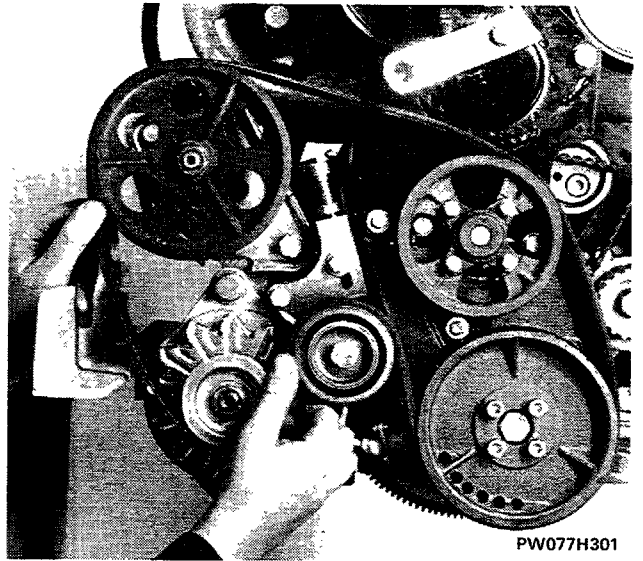

PW077H301

Fitting alternator, water pump and power steering pump poly-V drivebelt

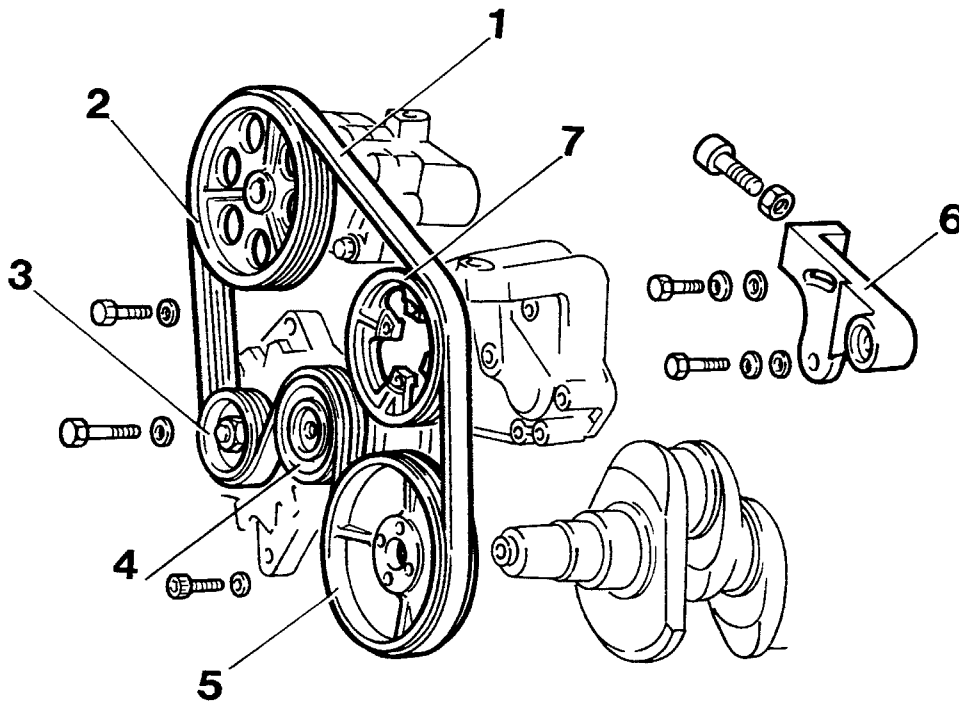

PW077H302

Components of the alternator, water pump and power steering pump drive system

1. Poly-V belt
2. Power steering pump pulley
3. Alternator pulley
4. Belt tensioner
5. Drive pulley
6. Belt tensioner mounting
7. Water pump pulley

10.

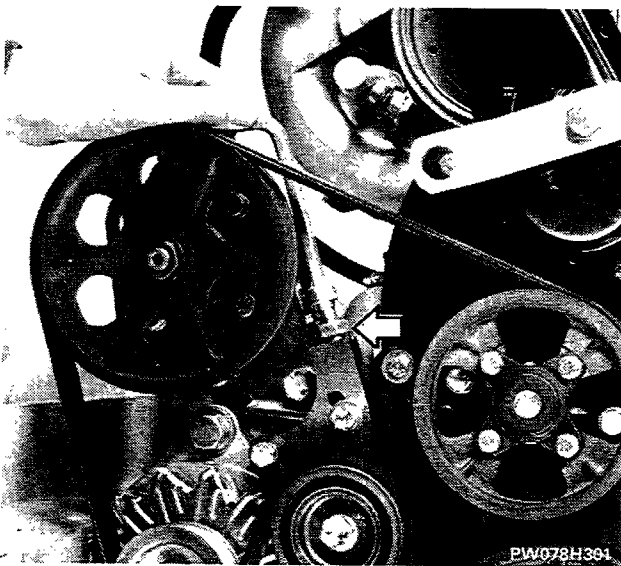

Adjusting tension of alternator, water pump and power steering pump poly-V drivebelt

NOTE *Adjust the tension by means of the adjusting bolt, as shown in the photo, then tighten the lock nut as indicated by the arrow.*

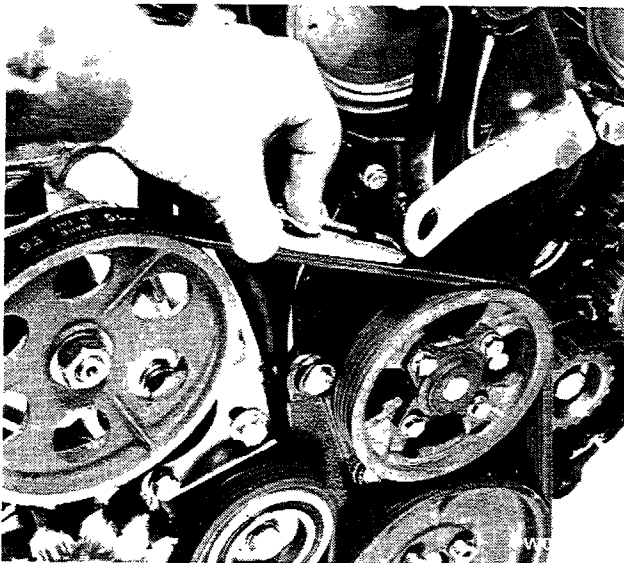

Checking tension of alternator, water pump and power steering pump poly-V belt

Check using tool 1895762000 that the belt tension is between 500 and 600 N.

Periodically check the belt every 20.000-30.000 km, and if the tension is below 250 N, retighten to 350 - 450 N.



The periodical checks on belt tension should be carried out when the engine is cold.

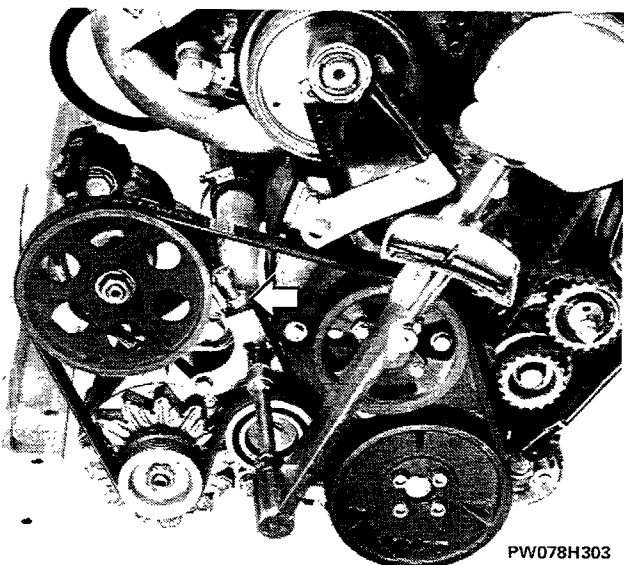

M8: 2,3 daNm
M10: 4,4 daNm

Tightening alternator, water pump and power steering pump poly-V belt tensioner bolts to correct torque

NOTE *The arrow shows the lock nut for the belt tension adjustment bolt, which should be tightened to the specified torque after the belt tension has been checked.*

Remove tool 1860744000 for rotating the flywheel.

Fitting timing belt front cover

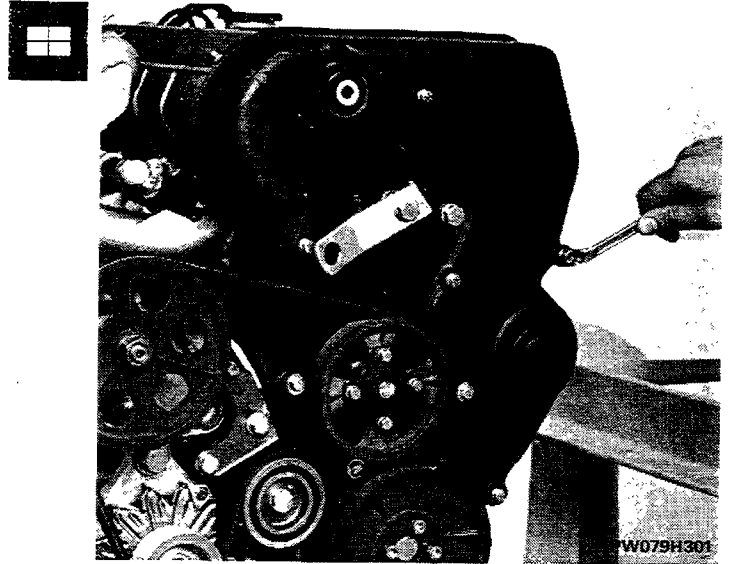

4,3 daNm

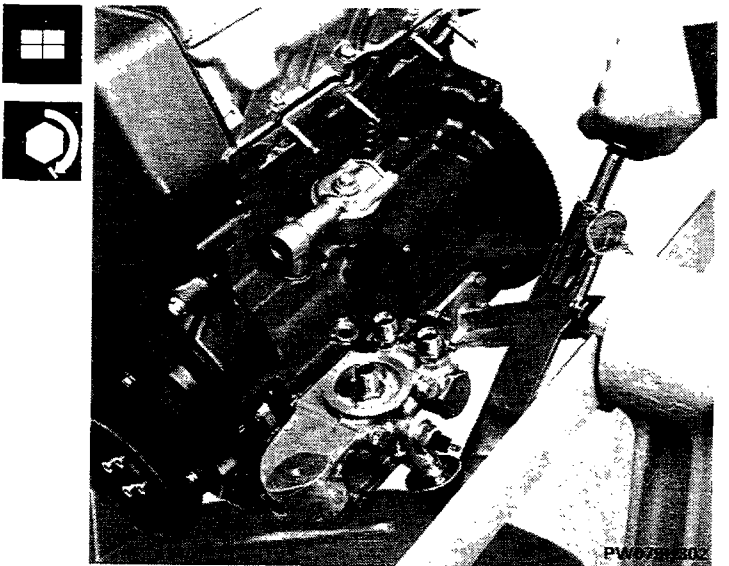

Fitting oil filter mounting and tightening its bolts to the correct torque

Fitting cartridge oil filter

NOTE Before fitting the oil filter, lubricate the seal with engine oil then screw it into its mounting by hand.

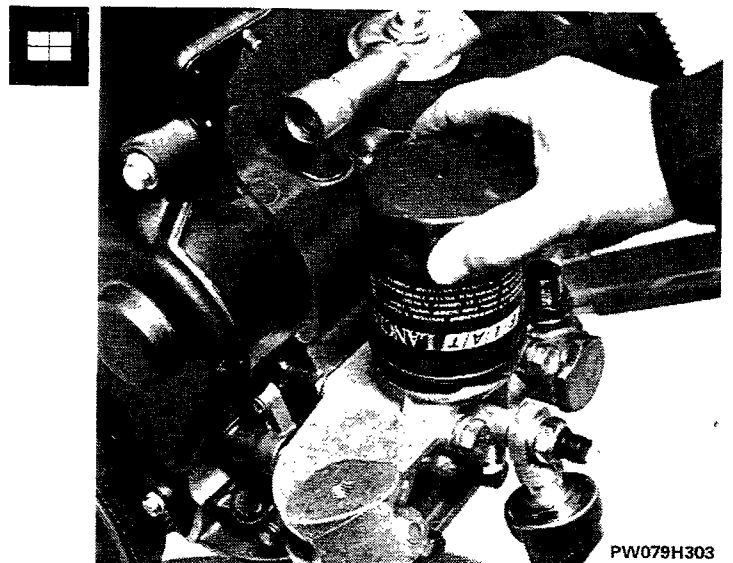

10.

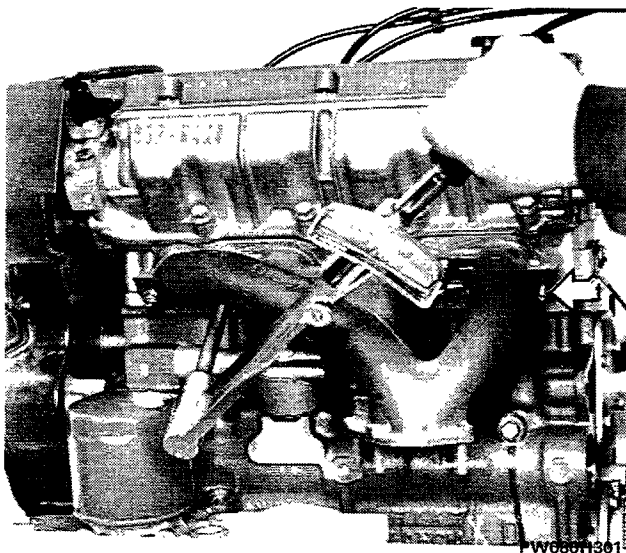

2,9 daNm

Fitting exhaust manifold and tightening its nuts to the correct torque

NOTE *One stud (arrowed) is left without its nut, this should be torque tightened after fitting the crankcase breather pipe.*

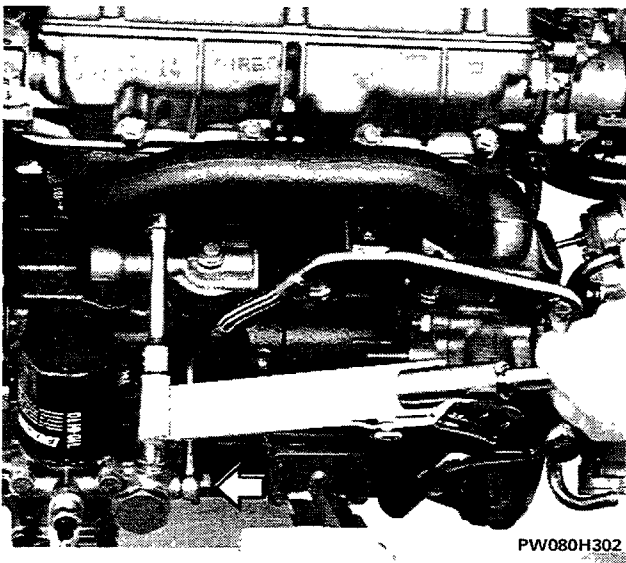

**M8: 2,9 daNm
M10: 5,9 daNm**

Fitting exhaust manifold complete with turbocompressor and tightening its nuts to correct torque

NOTE *The arrow shows the bolt securing the oil delivery pipe to the turbocompressor, which should be tightened to a torque of 2.3 daNm.*

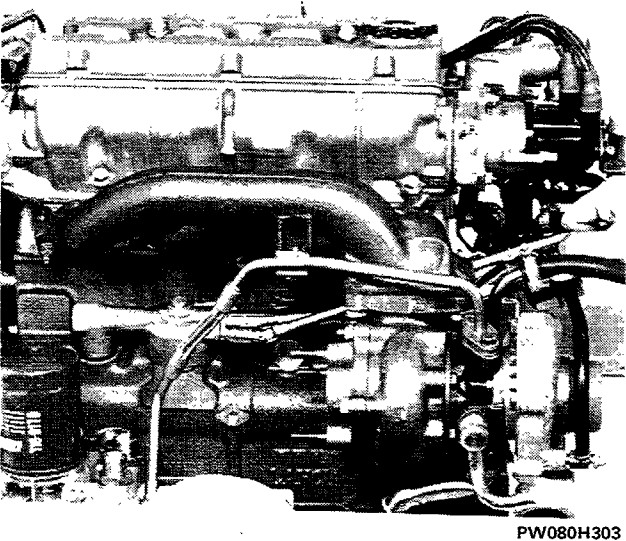

2,9 daNm

Fitting crankcase breather

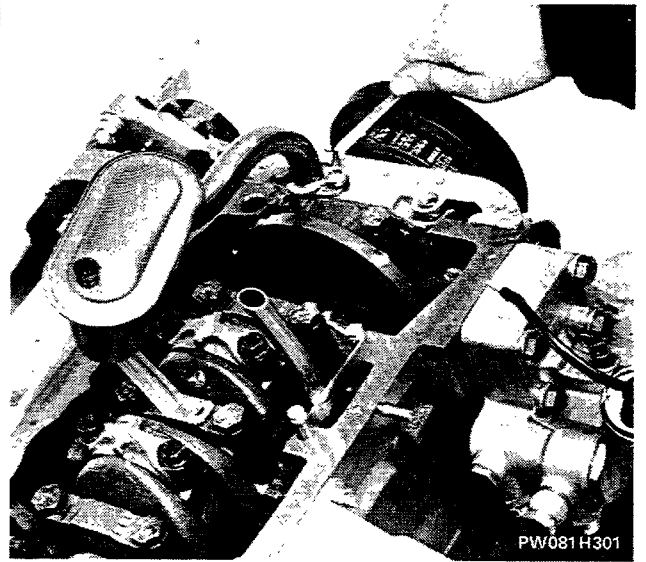

Fitting oil pump strainer and crankcase breather pipe on cylinder block

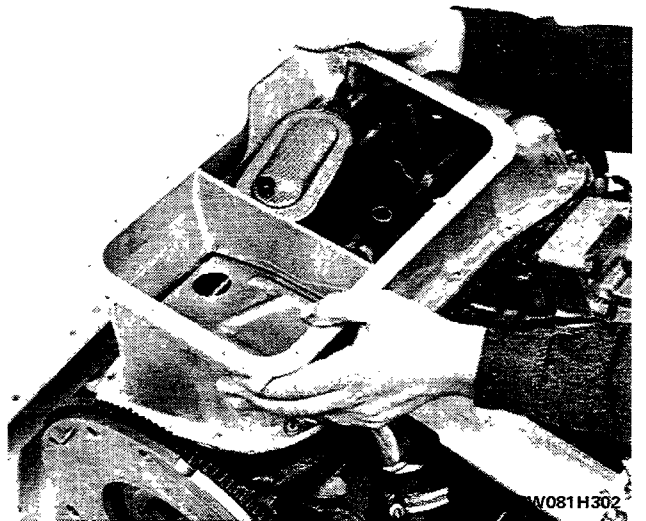

Fitting oil sump and gasket

NOTA *To position the oil sump on the cylinder block without damaging the oil pump strainer, make a rotary movement and then lay it down.*

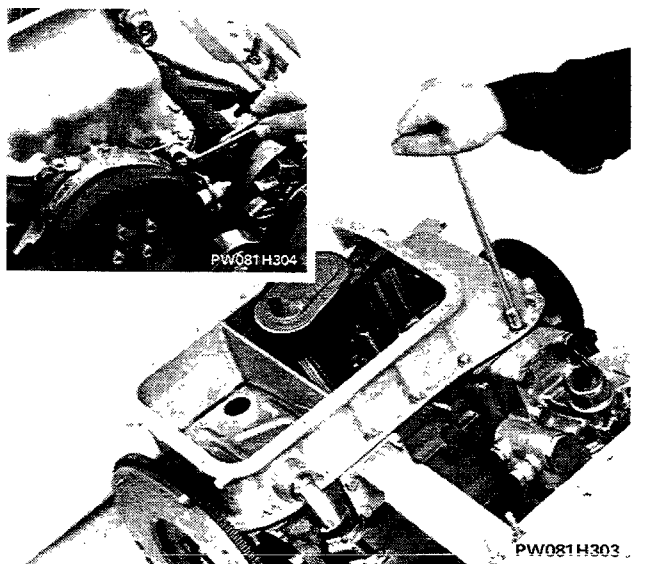

Tightening oil sump bolts on cylinder block and fitting timing belt bottom cover onto sump.

10.



Fitting oil sump cover

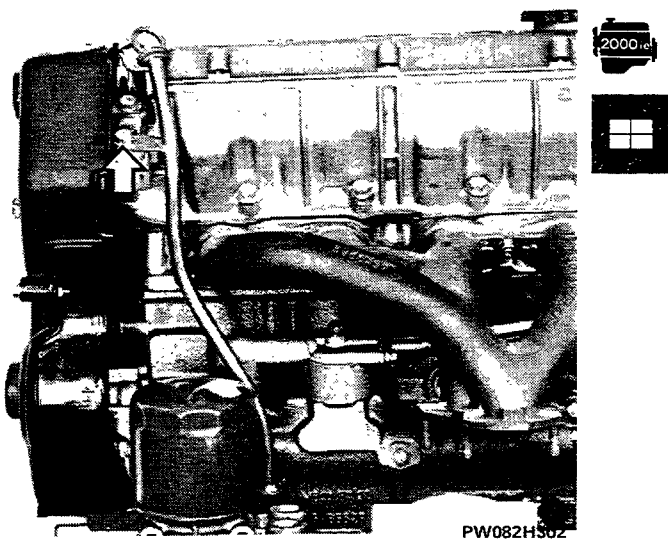

Fitting oil dipstick

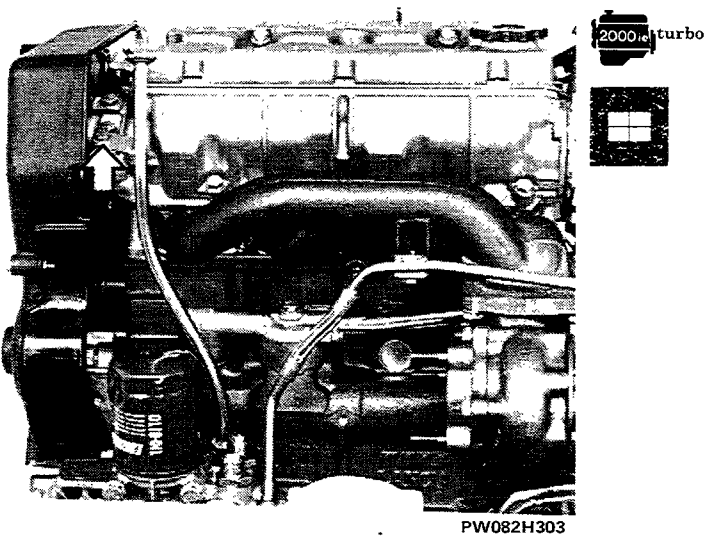

Fitting oil dipstick

DIAGRAM OF FUEL SYSTEM (diagram shows fuel system of DELTA 4WD)

1. Fuel filter
2. Fuel gauge sender
3. Fuel tank
4. Fuel filler
5. Air-air heat exchanger (intercooler)
6. Immersed fuel pump
7. Pressure regulator
8. Turbocompressor

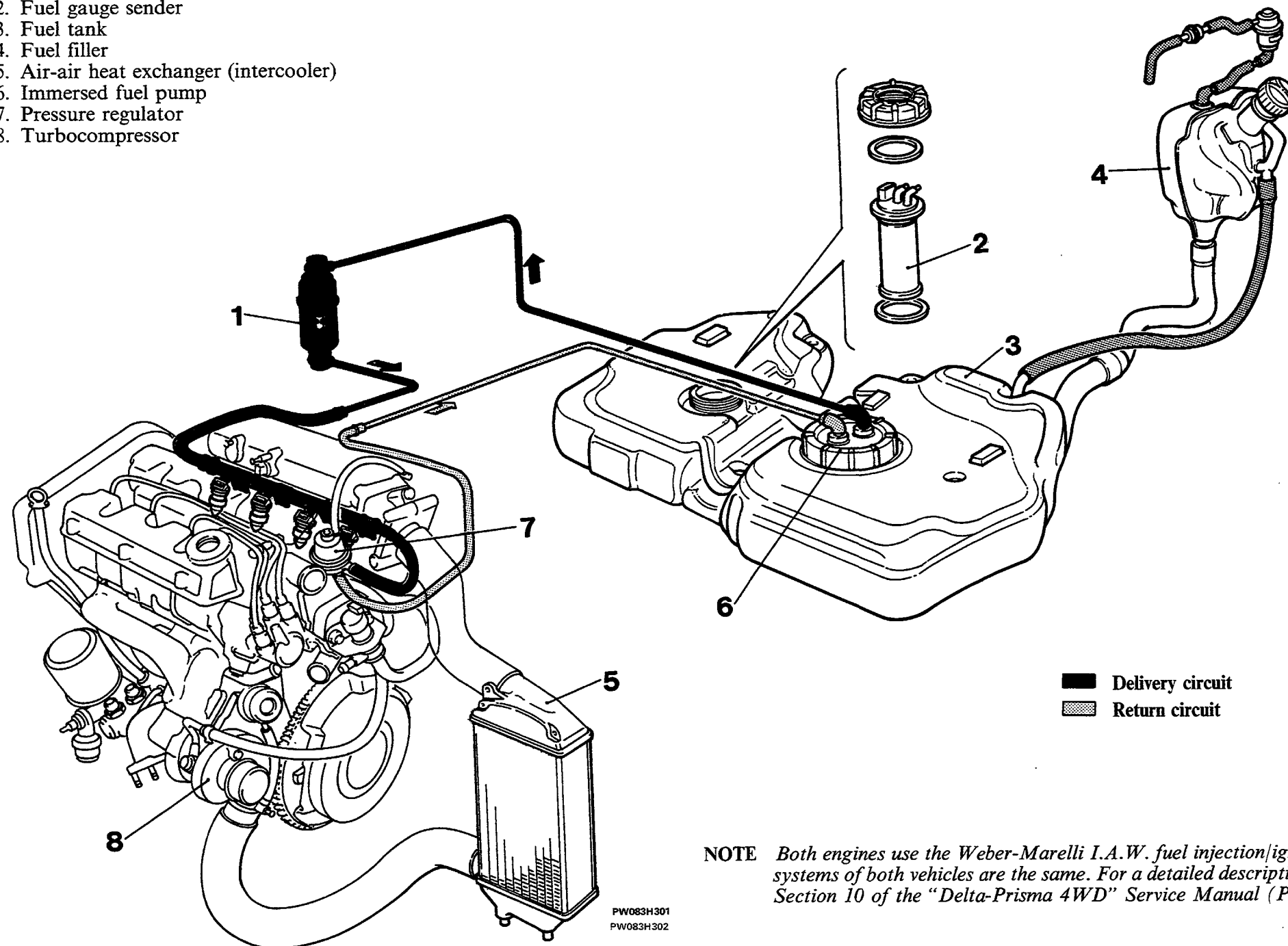

NOTE Both engines use the Weber-Marelli I.A.W. fuel injection/ignition system, so the fuel systems of both vehicles are the same. For a detailed description of the system, refer to Section 10 of the "Delta-Prisma 4WD" Service Manual (Publication n° 504.787).

General information

The fuel supply is provided by an electric fuel pump (6) immersed in the tank (3); this pump draws the petrol and delivers it to the filter (1) and then to the injectors. The fuel delivery pressure to the injectors is maintained constant and proportional to the inlet manifold pressure by a pressure regulator (7). This device is particularly important in the case of the turbocharged engine, in order to maintain a constant pressure differential for the injector, whatever the pressure delivered by the turbocompressor (8). Excess petrol flows back unpressurized from the pressure regulator (7) into the tank (3).

REMOVING/REFITTING INLET MANIFOLD

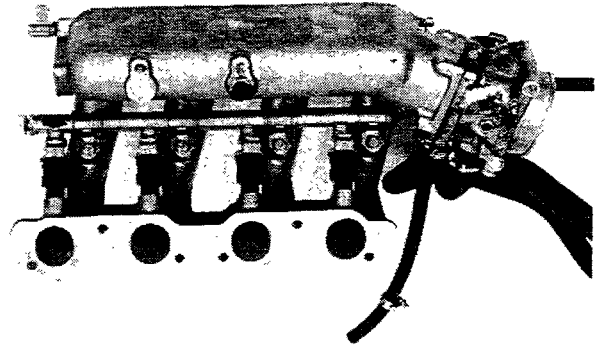

Inlet manifold assembly

PW085H301

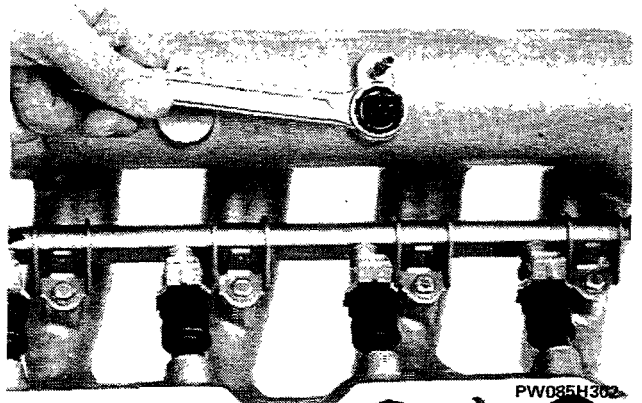

Removing/refitting air temperature sensor in manifold

PW085H302

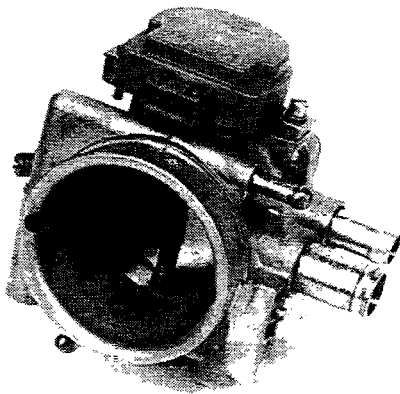

PW085H304

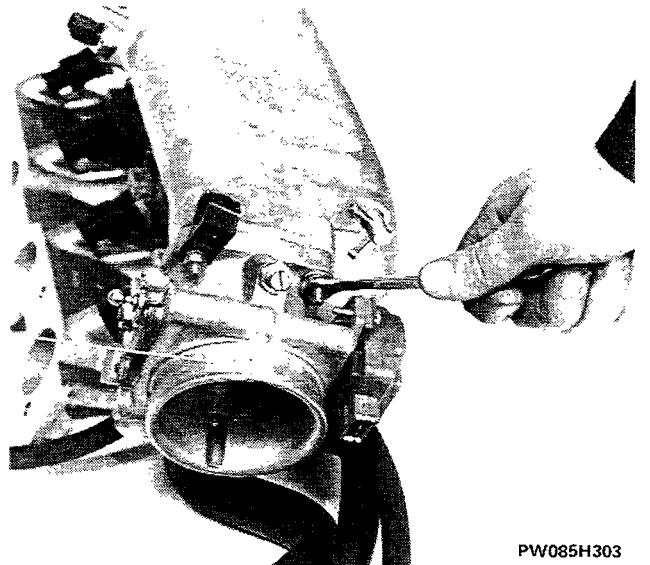

Removing/refitting throttle body

PW085H303

10.

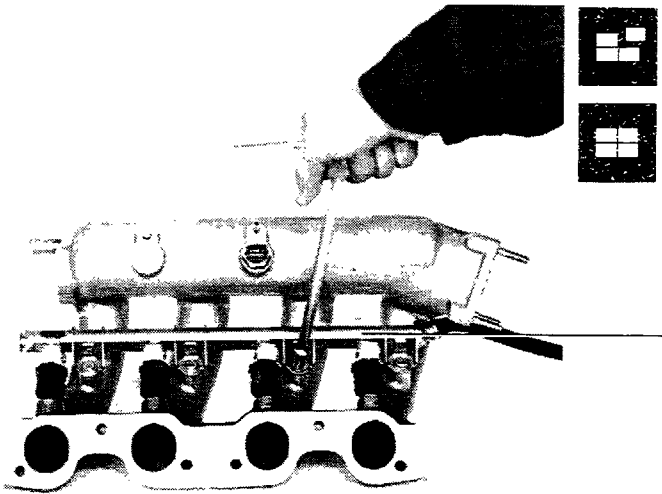

PW086H301

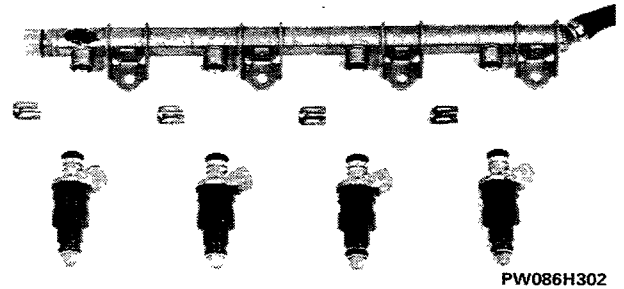

PW086H302

Removing/refitting injector unit

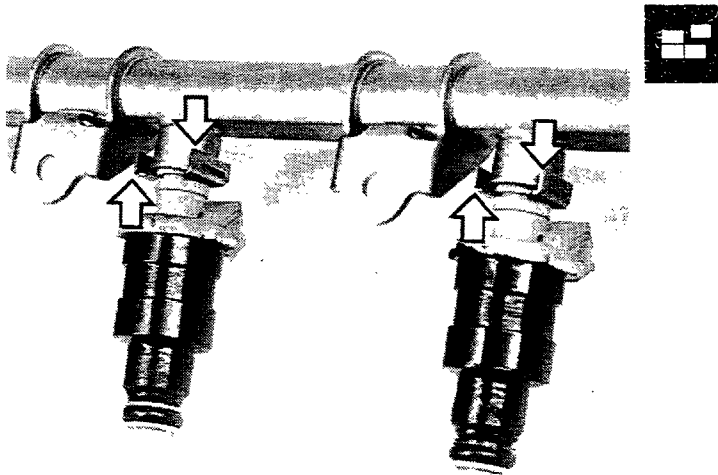

PW086H303

Dismantling injector

NOTE Slip off the retaining clip by pressing on the points indicated by the arrows, and remove the injector.

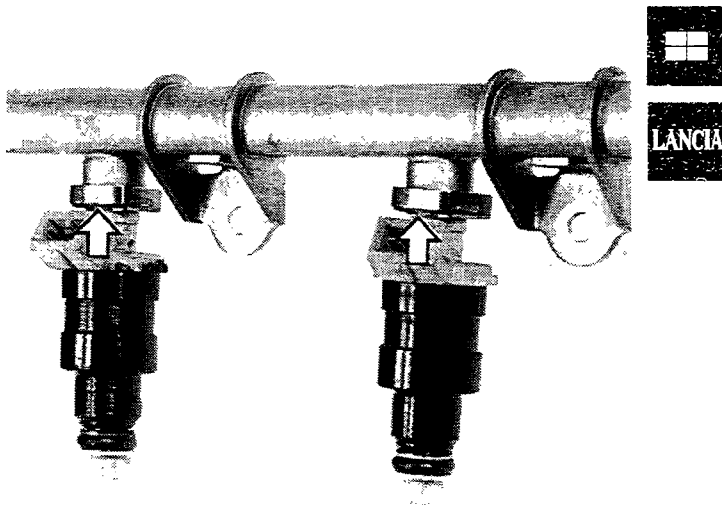

PW086H304

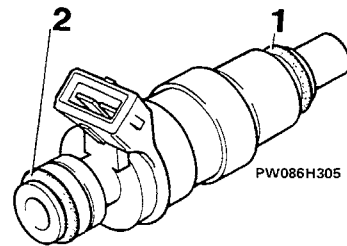

PW086H305

Fitting injector



Before fitting the injector, check the condition of its sealing rings (1) and (2), and renew if necessary.

To refit the injector, reverse the order of removal, inserting the retaining clip and pressing at the point arrowed in the photo.

WATER PUMP

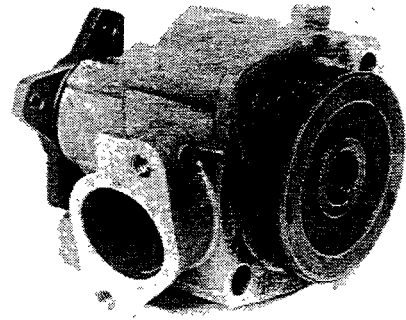

Water pump assembly

PW087H301

0,6 ÷ 1

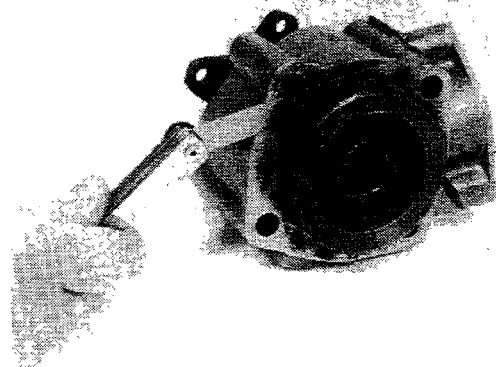

Checking clearance between impeller blades and pump casing

NOTE *The clearance between the impeller blades and pump casing must be between 0.6 and 1 mm. If the clearance is incorrect, or the casing is distorted or cracked, renew the complete pump.*

PW087H302

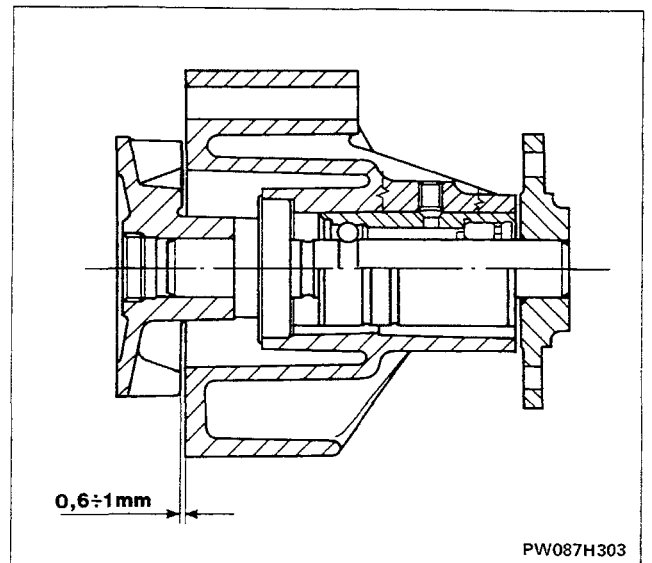

PW087H303

Section view of water pump

10.

THERMOSTAT

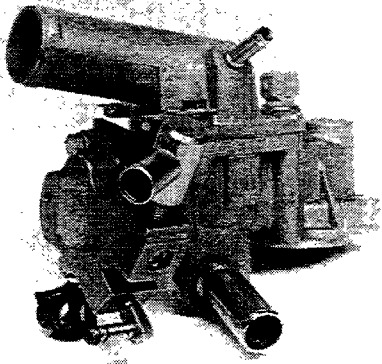

PW088H301

Thermostat assembly

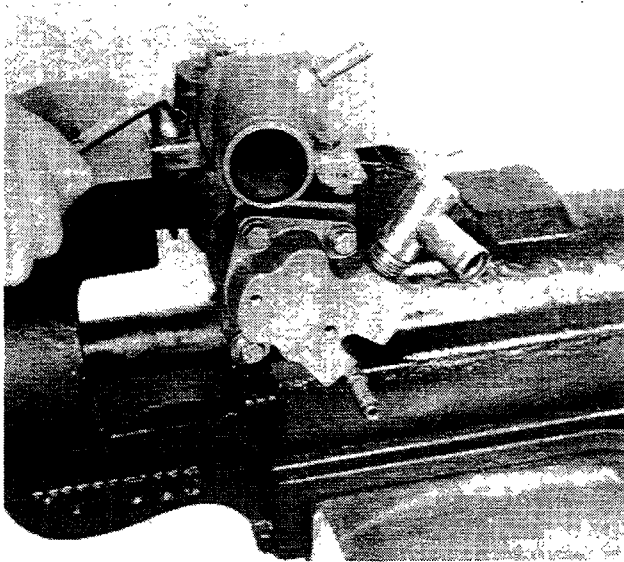

Removing/refitting thermostat

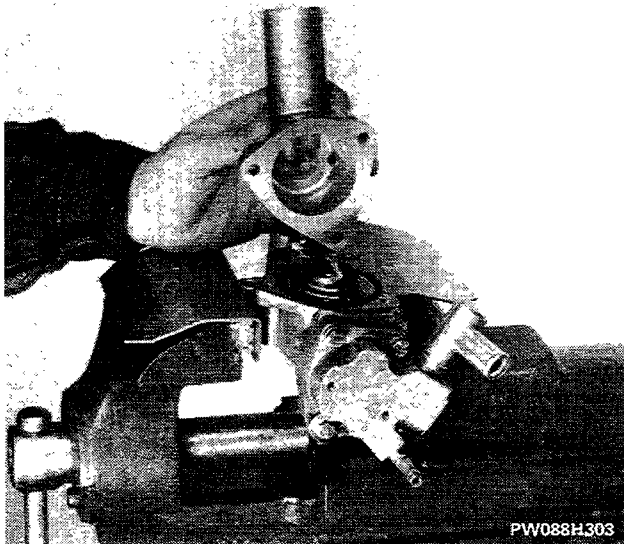

PW088H303

Removing thermostat top cover

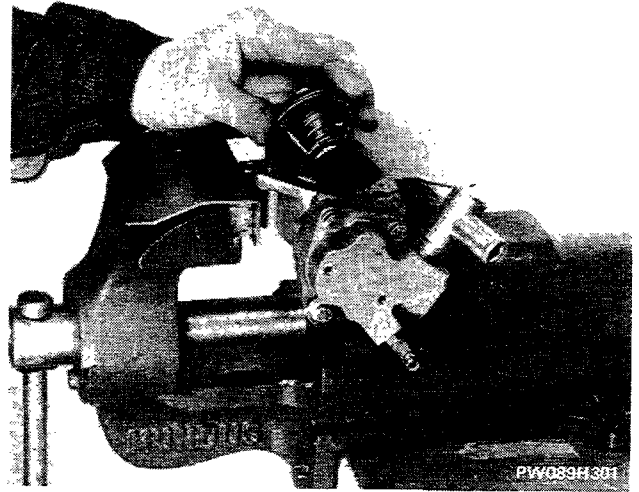

Removing/refitting thermostatic valve



PW089H304

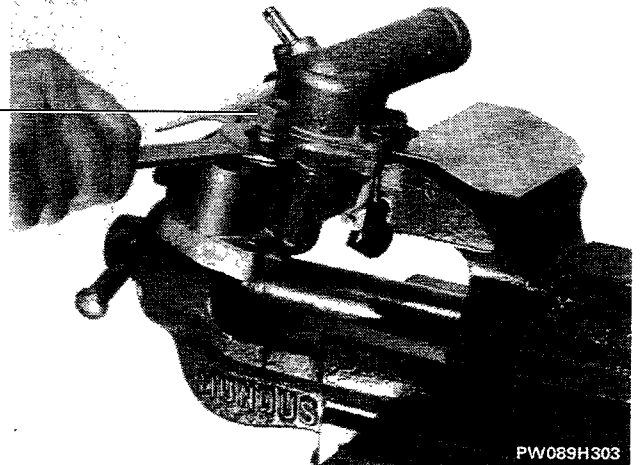

Removing/refitting thermal switch

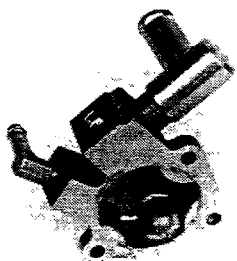

PW089H305

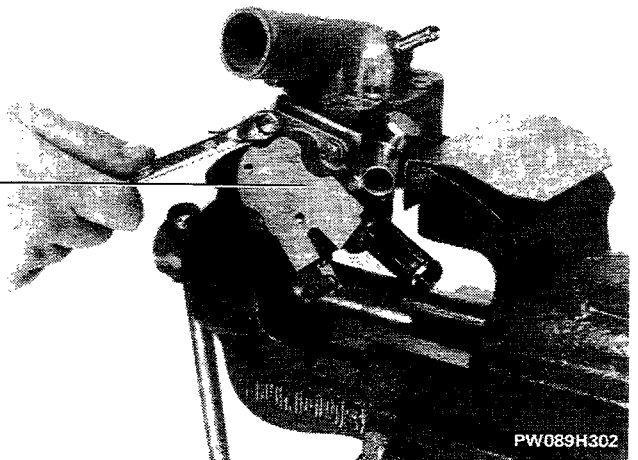

Removing/refitting auxiliary air solenoid mounting plate

PW089H302

10.

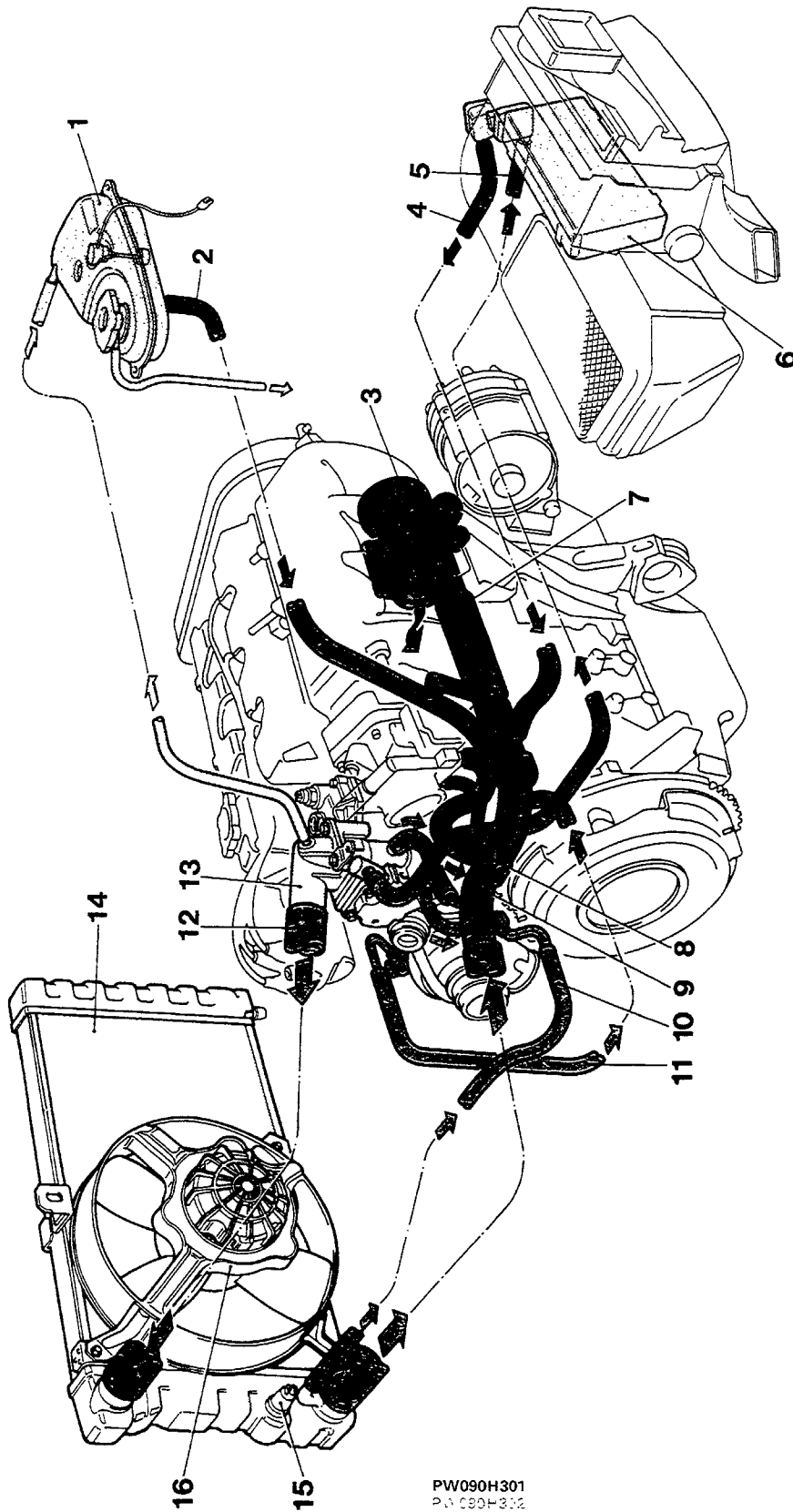

PW090H301
P.A. C90H-312

DIAGRAM OF COOLING SYSTEM

- | | | |
|--|--|---|
| 1. Expansion tank | 7. Manifold | 12. Delivery pipe from thermostat to radiator |
| 2. Return pipe from expansion tank to manifold | 8. Delivery pipe from thermostat to throttle body | 13. Thermostatic valve |
| 3. Water pump | 9. Return pipe from throttle body to manifold | 14. Radiator |
| 4. Return pipe from heater to manifold | 10. Delivery pipe from radiator to turbocompressor | 15. Electric fan thermostatic switch |
| 5. Delivery pipe from thermostat valve to heater | 11. Return pipe from turbocompressor to manifold | 16. Electric fan |
| 6. Heater | | |

Operation

The coolant is delivered to the cylinder block by the pump (3), which is crankshaft driven via a poly-V belt. After circulating around and cooling the cylinders and cylinder head, the coolant reaches the bypass pipe inside the thermostat body (13). From here, some of it returns directly to the manifold (7) through outlet E, and some of it emerges through outlets C and D and reaches the heater assembly (6) and throttle body. It then returns to the manifold (7), and is drawn in again on the vacuum side of the pump. When the coolant warms up, the thermostatic valve inside the thermostat begins to open, diverting an increasing flow of coolant to the radiator (14) through outlet B and the expansion tank (1) through outlet A. So, when the engine is hot, there is always coolant circulating in the expansion tank.

The expansion tank (1) comprises a pressure relief valve for regulating the pressure in the circuit.

When the coolant temperature reaches 85-89°C, a thermostatic switch (15) located at the bottom of the radiator (14) enables the fan (16) to come on and to accelerate the air flow through the radiator, thus increasing the cooling.

The cooling system of the 2000 i.e. turbo (Delta 4WD) uses coolant to cool the turbocompressor body. A pipe (10) draws the coolant directly from the cooling radiator (14) and another pipe (11) draws it at the outlet and delivers it directly into the manifold (7).

Thermostatic valve closed position (cold engine)

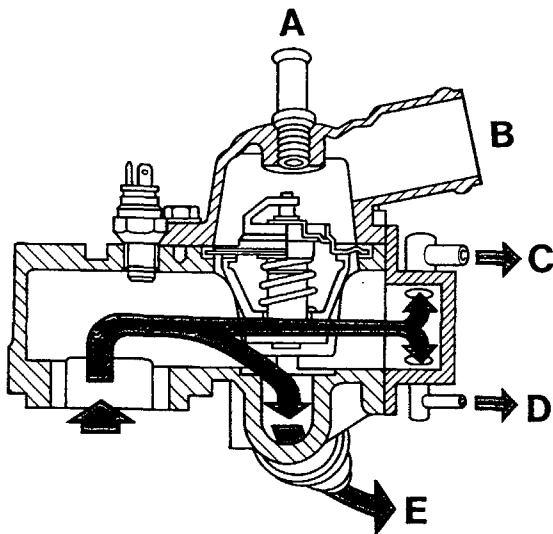

Thermostatic valve open position (hot engine)

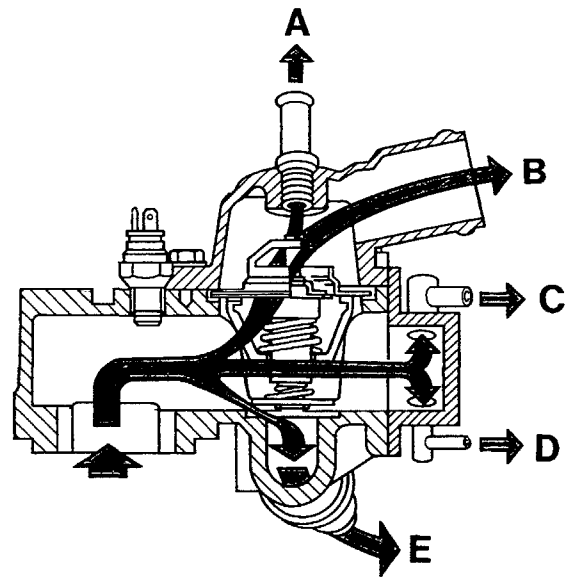

PW091H301
PW091H302

- A. Flow to expansion tank
- B. Flow to radiator
- C. Flow to heater
- D. Flow to throttle body
- E. Flow to manifold

10.

DIAGRAM OF LUBRICATION SYSTEM (Delta 4WD)

NOTE The lubrication system illustrated and described is that of the Delta 4WD, since it is more complicated, comprising a turbocompressor. The lubrication system of the Prisma 4WD is the same, except that it has no turbocompressor lubrication circuit.

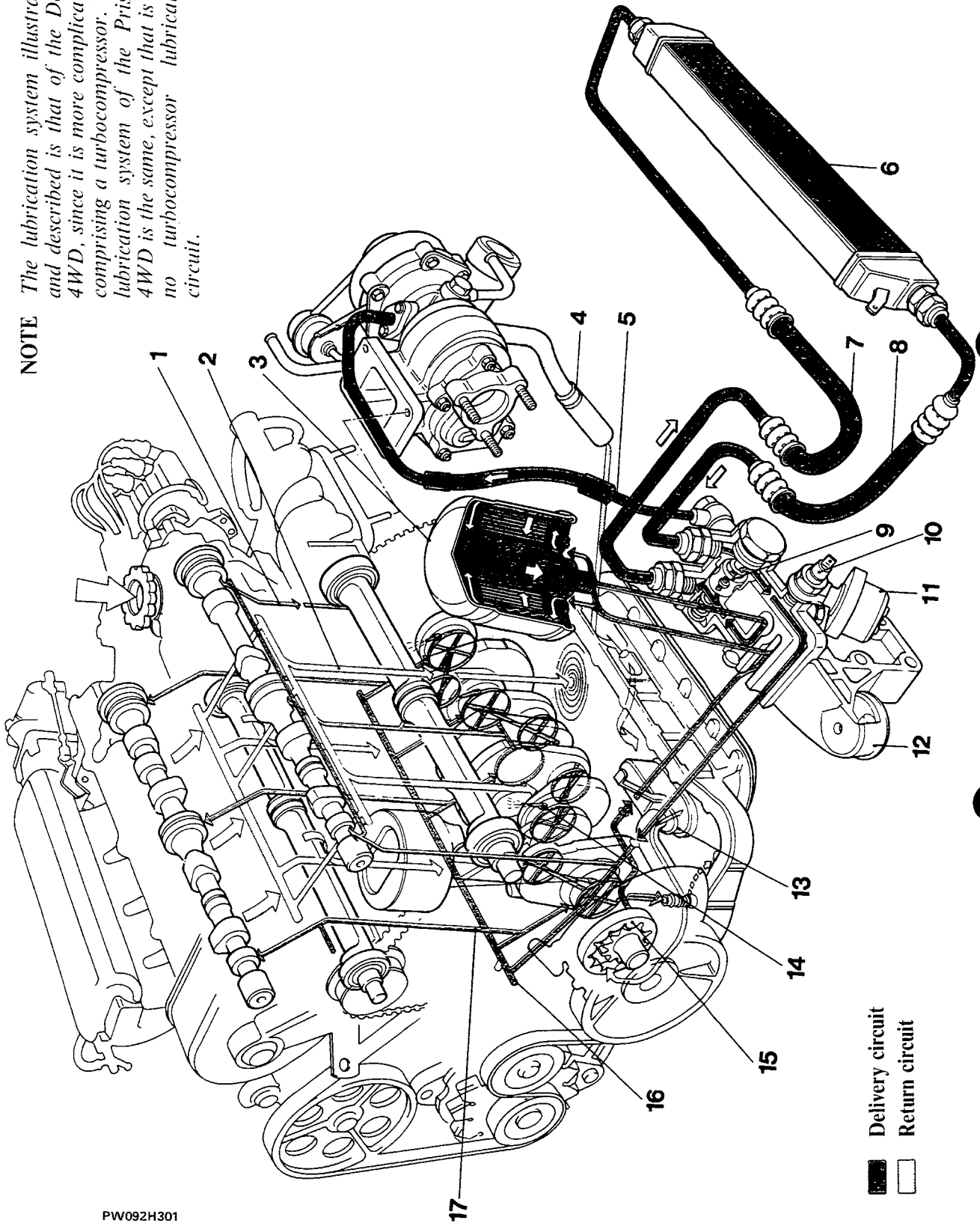

PW092H301
PW092H302

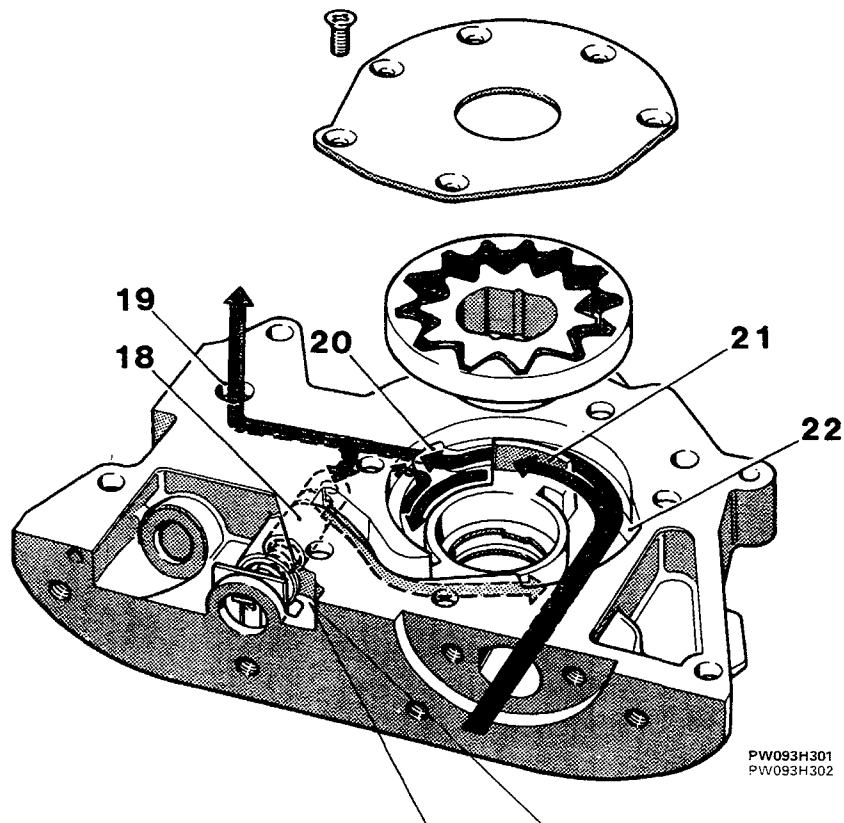

1. Counter shaft lubrication pipe
2. Oil return pipe to cylinder block
3. Full-flow oil filter
4. Oil return pipe from cylinder block to turbocompressor
5. Oil delivery pipe to turbocompressor
6. Oil radiator
7. Oil delivery pipe to radiator
8. Oil return pipe from radiator
9. Thermostatic bypass valve
10. Minimum oil pressure switch
11. Oil pressure switch
12. Oil filter mounting
13. Oil pump pick-up
14. Piston cooling jets
15. Oil pump
16. Oil delivery pipe to main bearings
17. Oil delivery pipe to camshafts
18. Pressure relief valve
19. Oil delivery pipe from pump
20. Pressure chamber
21. Separating wall
22. Low pressure chamber

PW093H301
PW093H302

OPERATION OF THE PRESSURE RELIEF VALVE

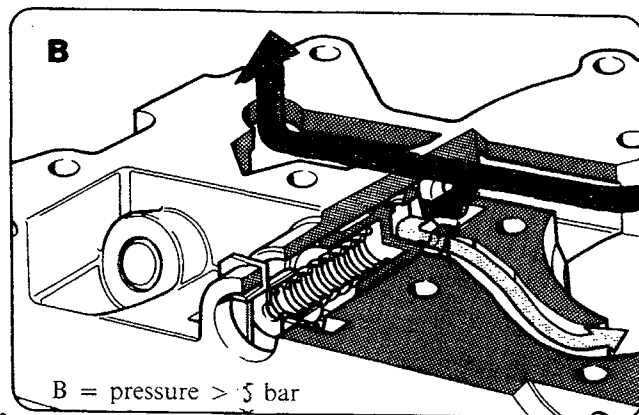
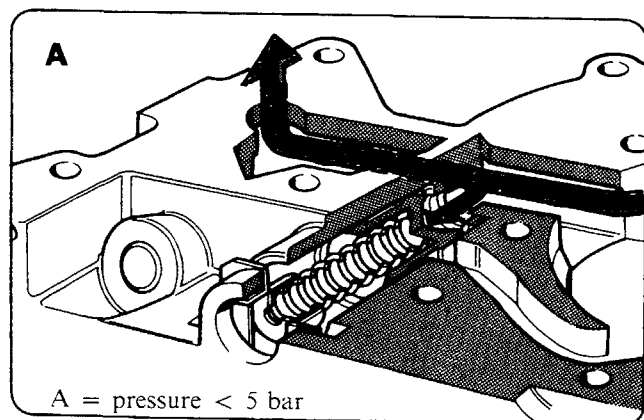

PW093H303
PW093H304

Description

The rotation of the oil pump gears (15), mounted directly on the crankshaft, creates a vacuum in the chamber (22) within the pump casing which draws oil from the sump through the pick-up (13).

The oil delivery pressure is present as from the separating wall (21) in the pump body, and this pressure is maintained constant by the pressure relief valve (18). The valve intervenes at pressures above 5 bar by opening direct communication between the pump's high and low pressure chambers. The oil is sent first to the cartridge filter (3), and then through the delivery pipes (5), (16) and (17) to the turbocompressor, main bearings and camshafts.

Some of the oil reaching the main bearings is sprayed by a set of jets (14) onto the piston inner surfaces to help cool them.

On the return circuit, the pipe (2) conveys oil to the counter shaft bearings and then to the oil sump.

If the oil temperature exceeds a certain limit, a thermostatic by-pass valve (9) diverts some of the oil flow emerging from the filter to the radiator (6) before it is delivered into the lubrication circuit.

The pressure signal for the instrument panel gauge is taken from the pressure switch (12), while the pulse for the low oil pressure warning light is sent from the switch (10); both sensors are located on the oil filter mounting.

10.

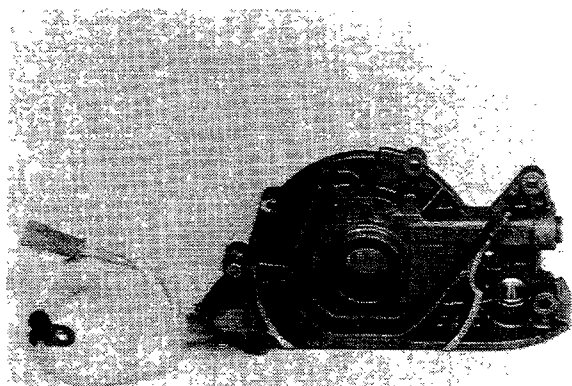

CRANKSHAFT-DRIVEN OIL PUMP



PW094H301

Crankshaft front cover with incorporated oil pump

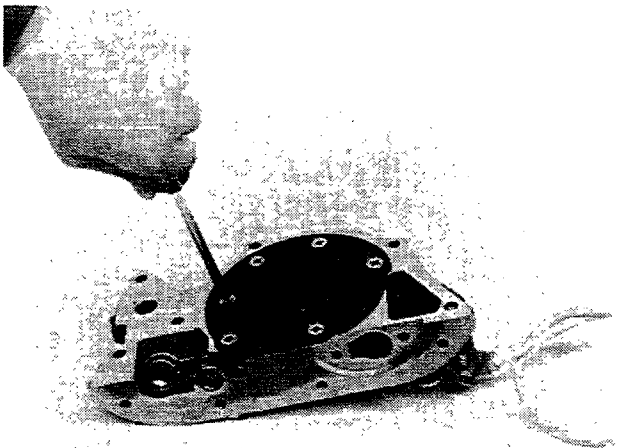

PW094H302

Removing/refitting oil pump sealing plate



$0,080 \div 0,186$

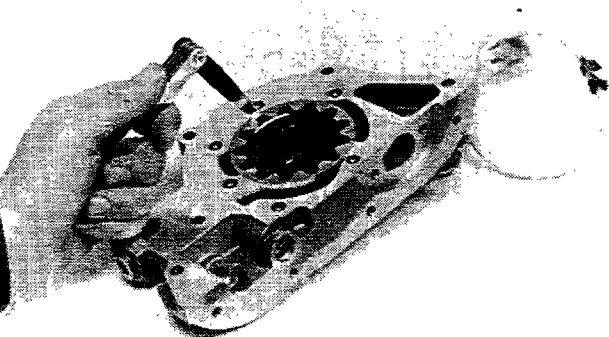

PW094H303

Checking clearance between pump casing and driven gear

0,025 ÷ 0,056

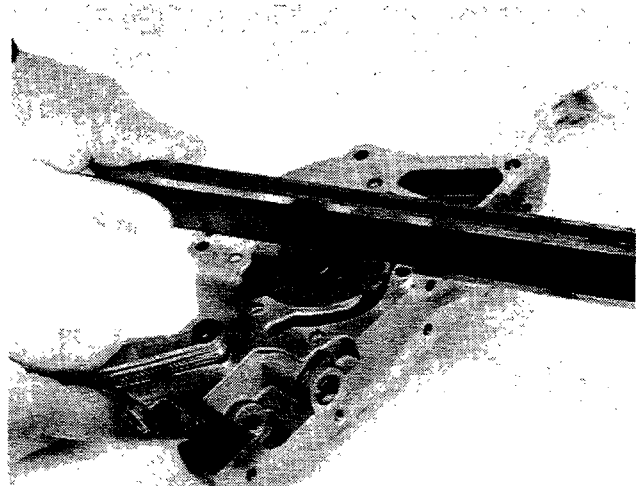

PW095H301

Checking clearance between pump cover supporting surface and pump gear top face

NOTE If the clearance is incorrect, renew the front cover with incorporated oil pump.

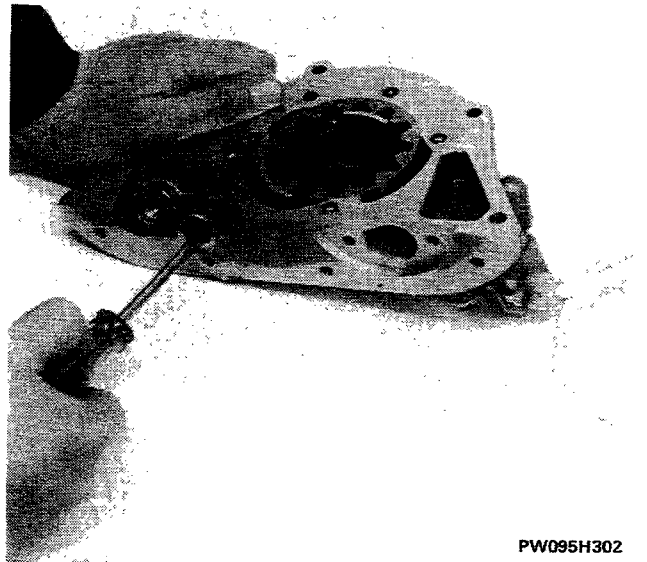

PW095H302

Removing/refitting oil pressure relief valve spring

Crankshaft front cover with incorporated oil pump

1. Cover body
2. Oil pump driven gear
3. Oil pump drivegear
4. Oil pump sealing plate
5. Relief valve spring
6. Pressure relief valve
7. Relief valve housing

- A. Oil inlet pipe from sump
B. Oil delivery pipe to cylinder block

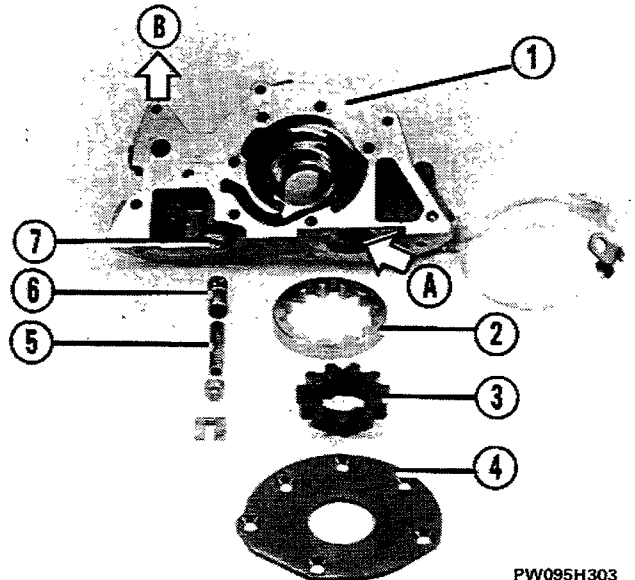

PW095H303

10.A

- 1840207814** Part (∅ 18-22 mm) for extracting counter shaft front bearings from cylinder block (use with 1840206000)
- 1850087000** Spark plug spanner
- 1850088000** Spanner for manifold nuts
- 1850095000** Spanner for water pump pipe bolts on cylinder block
- 1850113000** Spanner with 1/2" attachment for top cylinder head bolts
- 1853003000** Spanner (19 mm) for camshaft sprocket bolt, in vehicle
- 1854033000** Spanner for electric fuel pump or tank fuel filter retainer
- 1854038000** Spanner for fuel sender retainer
- 1856131000** Spanner for knock sensor on cylinder head
- 1858013000** Spanner for holding Bosch alternator pulley while removing/refitting nut
- 1860054000** Drift for removing and refitting small end bush
- 1860162000** Pressure gauge with connections for engine oil pressure
- 1860183000** Pliers for removing/refitting piston rings
- 1860251000** Drift for removing/refitting crankpin
- 1860303000** Tool for fitting gudgeon pin circlips
- 1860313000** Tool for fitting valve guide oil seals
- 1860322000** Board for supporting cylinder head during valve removal and refitting
- 1860395000** Drift for removing and refitting valve guides
- 1860456000** Tool for supporting cylinder head during tappet shim replacement using a vice
- 1860470000** Tool for supporting cylinder head during overhaul
- 1860473000** Tool for locking auxiliary components and camshaft sprockets
- 1860490000** Tool for holding valve seal tester 1895868000 (use with 1860470000)
- 1860592000** Universal hook for hoisting and transporting engine/gearbox unit
- 1860605000** Sleeve for installing pistons in cylinders
- 1860644000** Tool for removing and refitting valves
- 1860662000** Tool for removing oil filter
- 1860744000** Tool for rotating crankshaft at the bench
- 1860745100** Tool for adjusting timing belt tension (use with special parts)
- 1860745200** Part for adjusting timing belt tension (use with 1860745100)
- 1860745400** Part for adjusting counter-rotating shaft belt (use with 1860745100)
- 1860751000** Drift for fitting valve guides
- 1860757000** Tool for removing cartridge oil filter (2000 i.e. engine)
- 1860758000** Tool for removing cartridge oil filter (2000 i.e. turbo engine)
- 1861001011** Pair of brackets for securing engine to rotating stand 1861000000
- 1867029000** Flywheel locking tool
- 1867055000** Tool for locking tappets while replacing shims during valve clearance adjustment
- 1876036000** Lead with contacts for turning engine during valve clearance adjustment
- 1887001000** Pliers for withdrawing tappet shims
- 1890310000** Sleeker for valve guide bores
- 1895362000** Cooling system leak tester
- 1895683000** Cylinder compression tester
- 1895683002** Cards for tester 1895683000
- 1895762000** Tool for checking poly-V belt tension
- 1895868000** Valve seal tester
- 1895879000** Tool for checking piston no. 1 TDC for sensor mounting plate positioning (use with 1895881000)
- 1895895000** Tool for positioning sensor mounting plate, timing gear side (use with 1895879000)
- 1895896000** Tool for positioning distributor rotor arm (IAW)
- 1896218000** Gauge for checking valve stem height after recutting seats in cylinder head

PART	Thread	Torque wrench settings
		daNm

ENGINE

Central main bearing cap bolt	M 12 x 1.25	2 + 130°
Main bearing cap self-locking bolt	M 12 x 1.25	2 + 90°
Nut securing tie-rod to aluminium sump and torque distributor	M 8	2.3
Bolt securing crankcase breather to cylinder block	M 8	2.3
Bolt securing reaction bracket to torque distributor	M 10 x 1.25	5.9
Cylinder head bolt	M 10 x 1.25	4 +90° +90°
Top cylinder head bolt	M 8	2.2
Bolt securing inlet manifold to cylinder head	M 8	2.5
Nut securing inlet manifold to cylinder head	M 8	2.5
Nut securing reaction bracket to inlet manifold	M 8	2.3
Bolt securing reaction bracket to inlet manifold	M 8	2.3
Self-locking nut securing exhaust manifold	M 8	2.9
Bolt securing connecting rod cap	M 10 x 1	2.5 + 50°
Bolt securing flywheel to crankshaft	M 12 x 1.25	14.2
Bolt securing auxiliary components' pulley to camshaft sprocket	M 8	2.5
Bolt securing crankshaft sprocket ▲	M 14 x 1.5	19
Bolt securing belt tensioner bearing to mounting	M 10 x 1.25	4.4
Bolt securing belt tensioner mounting to alternator and power steering pump mounting	M 8	2.3
Lock nut for poly-V belt tension adjustment bolt	M 10 x 1	4.4
Camshaft sprocket bolt	M 12 x 1.25	11.8
Belt tensioner bolt	M 10 x 1.25	4.4

▲ The bolt must **not** be lubricated

Engine

Torque wrench settings



10.

PART	Thread	Torque wrench settings
		daNm
Counter-rotating shaft sprocket bolt	M 12 x 1.25	11.8
Counter-rotating shaft cover bolt	M 8	2.3
Nut securing counter-rotating shaft belt tensioner	M 8	2.3
Self-locking nut securing turbocharger to exhaust manifold	M 10 x 1.5	5.9
Self-locking nut securing flange to turbocharger	M 8	2.9
Bolt securing turbocharger bracket to cylinder block	M 8	2.9
Nut securing turbocharger bracket and exhaust pipe bracket to cylinder block	M 8	2.9
Bolt securing oil delivery pipe to turbocharger	M 8	2.3
Connection for adjustable connection securing oil delivery pipe to oil filter housing	M 14 x 1.5	5
Bolt securing oil delivery pipe bracket to exhaust manifold	M 10 x 1.25	4.3
Bolt securing oil return pipe from turbocharger to sump	M 8	2.3
Connection for adjustable union securing turbocharger cooling water delivery and return pipes	M 16 x 1.5	3.2
Bolt securing oil filter mounting and engine mounting to block	M 10 x 1.25	4.3
Cap for thermostatic valve on oil filter mounting	M 35 x 1.5	11.8
Bolt securing water pump to block	M 8 x 1	2.5
Bolts securing water pump and power unit mounting bracket to block	M 8 x 1	2.5
Bolt securing water pump connector to pump	M 8	2.5
Bolt securing complete water return pipe to cylinder head	M 10 x 1.25	4.3
Nut securing alternator and power steering pump bracket to block	M 10 x 1.25	4.3
Bolts securing alternator and power steering pump bracket to block	M 10 x 1.25	4.3
	M 8	2.5

PART	Thread	Torque wrench settings
		daNm
Bolt securing alternator bracket to mounting	M 10 x 1.25	4.3
Alternator bracket nut	M 10 x 1.25	4.3
Alternator nut	M 12 x 1.25	6.9
Bolt securing brackets to power steering pump	M 8	2
bolt securing power steering pump brackets to mounting	M 10 x 1.25	4.3
Nut securing power steering pump pulley	M 14 x 1.5	9.5
Spark plugs	M 14 x 1.25	3.7
Oil temperature sender	M 14 x 1.5	3.7
Water temperature sender	M 16 x 1.5 tapered	4.9
Oil pressure switch	M 14 x 1.5	3.2
Oil sump plug	M 22 x 1.5 tapered	5